



ALSANIT®

PRODUCT BOOK

We create spaces

We produce in Poland

„For my Dad, without him there would be nothing.”

T.H.

ABOUT US

STRONG POLISH AND EUROPEAN BRAND	4
PROFESSIONAL CUSTOMER SERVICE	6
FROM PROJECT TO REALIZATION	7
COOPERATION WITH DESIGNERS	8
SHORT LEAD TIMES	12
ECOLOGY	14

LOCKERS AND BENCHES

COMBO	MODULAR, HPL / MFC / GLASS DOORS	19
TAURUS	HPL LOCKERS	33
ARTUS	HPL LOCKERS ON PROFILES	47
LUXA	MFC LOCKERS	61
VELA	METAL BODY, METAL / HPL / MFC DOORS	73
BENCHES		86
ADDITIONAL OPTIONS		90
LOCKS FOR LOCKERS		92

SMART LOCKERS

SMART LOCKERS	96
---------------	----

CONTRACT FURNITURE

RECEPTION DESKS	102
TABLES	106
CHAIRS AND SOFAS	108
GRIDO MODULAR SHELVING	111
SHELVING	112
PARTITIONS	116
SLATS	118
VANITY	120

TOILET CUBICLES

SOLARI	CUBICLES MADE OF HPL / MFC / SP	125
PERSEI	CUBICLES MADE OF HPL / MFC / SP	131
AQUARI	CUBICLES MADE OF HPL / MFC	137
LIFT	CUBICLES MADE OF MFC / HPL / SP	145
ALTUS	FULL-HEIGHT CUBICLES	151
VITRAL	CUBICLES MADE OF GLASS	157
URINAL PARTITIONS		162

HPL BUILT-INS

SHOWERS	166
VANITY TOPS	168
TECHNOWALL WALL CLADDINGS	171

COLORS	173
---------------	------------

CONTACT	178
----------------	------------

Strong Polish and European brand

About us

With passion and commitment, we have transformed a small family business into a leading European provider of equipment for investments. We can proudly say that the products we offer, which are designed and manufactured in Poland, are highly regarded in the most prestigious facilities worldwide.

We back the expertise of our professional team with the latest design and production technologies, which allows us to shape our company and deliver over 2600 projects annually.

Today ALSANIT is recognized on the market as a brand appreciated primarily for the exceptional quality and innovative design of offered products.

Our company continues to grow and deliver products that meet the highest standards, which makes us a trusted partner for customers globally.

ALSANIT IN NUMBERS:

20+

20 years of experience

25+

sales to over 25 countries

2600+

2600 projects annually

8000+

sqm of ALSANIT's hall space

40000+

doors produced annually

Mission

Our mission is to deliver the highest quality products designed for investment equipment. We aim to be a company whose products are confidently recommended and utilized worldwide.

Vision

We strive to set trends and participate in shaping the spaces of newly built facilities. Our products are designed to prioritize the users, ensuring they best meet their needs.



ALSANIT - WE CREATE SPACES



Our values:



Competences

We serve you with the knowledge and experience gained through the execution of various projects. We know how to assist our clients.



Creative thinking

It is primarily manifested in the individual approach to each client. Our goal is to provide the best possible response to every inquiry. Creative thinking is also the foundation for creating new product lines and accessories.



Order

High service standards, as well as a perfect organization of the production process at ALSANIT, are indispensable norms for maintaining a high position in the market, which requires punctuality and efficiency in order fulfillment.



Cooperation

We prioritize cooperation, both internally among employees and externally with suppliers and clients. We ensure that clients receive support from the first contact through offer and during installation. We appreciate loyal customers by offering them participation in partnership programs.



Reliability

Understood as punctuality, high quality of delivered products, and very good relationships with clients. Reliability is a particularly important value that we manage to achieve thanks to order and cooperation. Reliability guarantees customer satisfaction both with products and services provided.

Professional customer service



We explore the needs of your business

Each project is supervised by an individual coordinator who not only advises on the appropriate selection of materials and construction regulations but also ensures that everything runs smoothly and according to plan.

For us, the greatest reward is the success and satisfaction of our clients. By working with us, you receive not only a product but also a business partner.



High quality at an attractive price

By focusing on quality, we are mindful of the importance of being competitively priced. We invite you to submit your inquiries.



Short lead times

Timely and comprehensive service – from delivery to installation, allowing you to focus on other aspects of your business.



Dedicated customer service representative

Offers prepared within 48 hours, technical advice, and full information regarding the progress of the order.



Project support

A qualified team of designers capable of creating visualizations to support project implementations.

OUR PRODUCTS HAVE BEEN CHOSEN BY:



SKANSKA



From project to realization

Products tailored to the needs of each investment

Thanks to advanced technological capabilities and deep material knowledge, we offer a wide range of solutions for every investment. Basing on our experience, we select products that perfectly fit various facilities. With us, you have the opportunity to benefit from a comprehensive offer and enjoy the convenience of working with a single supplier - ALSANIT.

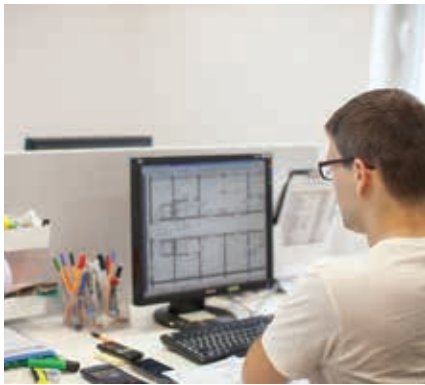

Technical consulting and offer

Tested solutions

We test our products and conduct regular quality assessments to ensure their highest quality. The provided warranty is a specific commitment, supported by the necessary approvals and certificates of our products. The certifications and approvals held by ALSANIT are recognized internationally.

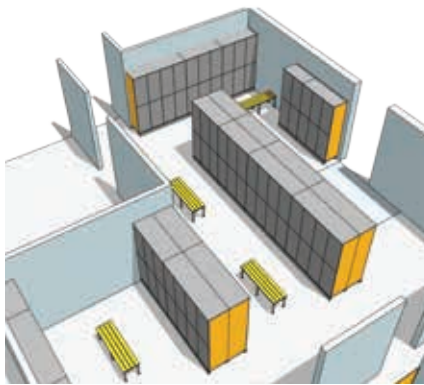

A team of experienced designers

With users in mind

We understand that the most important aspect in our industry is the human. Our solutions are based on analyzing the needs of users and observing their interactions with the provided products. Each project is a source of knowledge and insights for us. Based on this, we continually improve and expand our offer.

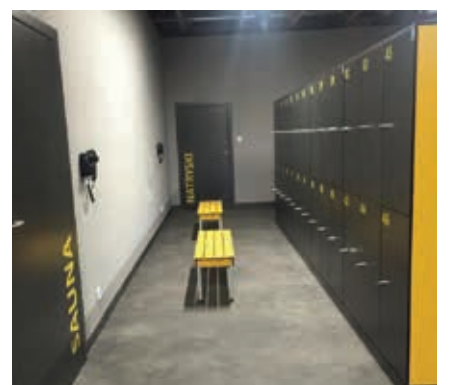

The shortest delivery and installation times



Modern machinery park



Cooperation with designers



Manager for cooperation with designers

We collaborate with designers to provide them with the necessary tools and materials to realize their design visions. Our dedicated representative will provide all the information and discuss the details of cooperation. If you are interested in our resources, such as drawings or descriptions, we encourage you to contact us.

CONTACT US



projekty@alsanit.pl

+48 728 881 841

We know that behind every successful project lies great cooperation. Our manager will help unleash the full potential in your projects and ensure the delivery of the necessary technical documentation for ALSANIT products.

Benefits of cooperation:



3D models library

We offer free design libraries, such as BIM, CAD, and SketchUp, containing models of our products.



Technical documentation

We provide comprehensive technical documentation, precise visualizations, and also customize products to individual needs.



Access to informational materials

Easy access to product catalogs, technical specifications, and drawing libraries.



Material samples

We have prepared samples of the materials used in our products.



One supplier of many products

We understand the requirements of architects, which is why we have such a comprehensive offer. We deliver products on time and ensure high-quality execution.



Certificates

Our products hold international certifications: TÜV – lockers, CE – cubicles.

OUR PRODUCTS HAVE BEEN INSTALLED IN FACILITIES DESIGNED BY:



Mercury Tower, Malta
Zaha Hadid Architects



VARSO Tower, Warsaw
Foster and Partners



Hilton Hotel, Rome
THDP



Dublin Airport
Desmond FitzGerald

Zurich Airport

Zurich Airport
Grimshaw



Skyliner, Warsaw
APA Wojciechowski

ALSANIT - QUALITY AND PASSION



Innovative products and production methods

Quality assurance through patents and certifications

Our products are backed not only by experience and professionalism but also by specific certifications and attestations, confirming their quality and safety. We hold necessary hygiene certificates, European Technical Assessments, and CE certificates issued by the renowned Institute of Building Technology and TÜV certificate.

We continuously strive for innovation. We independently develop and manufacture fittings and accessories for our products. We are proud to have designed a unique hinge that is now used in all our locker systems.

Our spirit of innovation is underscored by our patents and protected designs. Among them, it's worth mentioning:

- The revolutionary SAFE FINGERS system, enhancing comfort and safety of use.
- Innovative set of profiles for locker production, providing unlimited configuration possibilities.
- Modern system of metal modular lockers, combining aesthetics with functionality.
- Our proprietary ALSANIT hinges, which are the epitome of durability and reliability.

Each of our innovations is a response to market needs and a pursuit of excellence.



In-house carpentry workshop

- Automatic sheet warehouse with a capacity of 30,000m²,
- 4 CNC machining centers,
- 2 edgebanders using hot-air technology (glue-free).



In-house machining department

- 2 CNC lathes with automatic loading system,
- double-table CNC milling center,
- automated saws,
- CNC profile center,
- 3 eccentric presses.



In-house metal sheet processing line

- Automated sheet metal cutting line,
- 2 robotic CNC bending presses,
- welding stations.

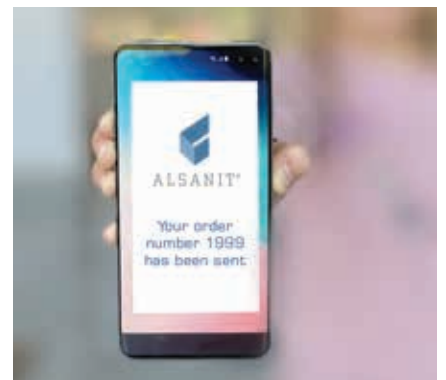

Production management application

We have developed and implemented an innovative workflow system, which ensures efficient and fast order fulfillment.



In-house painting line

Highly efficient fully automated paint line with automatic paint applicators.



In-house assembly department

A properly executed installation by experienced teams is the finishing touch to completing the project perfectly.

We are navigating towards modernity: we are growing and investing

Continuous investment in technological development and modernization of the production process is key to ALSANIT's success. Our modern machinery park is the foundation upon which we build efficiency and the ability to adapt to the individual needs of the customer.

Thanks to advanced technology, custom products have become commonplace for us, and their realization is done while maintaining the highest quality standards. Furthermore, the innovation of our machinery park allows for the streamlining of production processes, resulting in the quick fulfillment of orders, even the most specific ones.

We proudly observe how our determination to strive for excellence translates into products that meet both current and future market needs. Our readiness for continuous improvement ensures that ALSANIT will remain at the forefront of the industry, offering solutions that meet the expectations of even the most demanding customers.

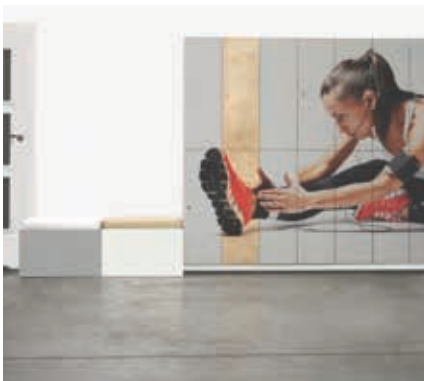

In-house design department

For business clients, we provide visualizations included in the project price.



In-house engineering department

A team of experienced engineers capable of executing the most ambitious projects.

Short lead times



7
standard production lead time for orders -
below 10 doors

10
standard production lead time for orders
- approximately 10-20 doors

14+
for larger projects, the time is
determined individually

Masters of process optimization

What sets us apart is not only our short lead times, but the entire integrated process of operation. Through closely monitoring each stage of production, automation, and eliminating unnecessary factors, we have achieved a level of efficiency that is difficult to beat.

As one of the few companies in the industry, we have automated warehouses for resources such as HPL boards, MFC boards, and accessories.

By having necessary materials in stock, we can fulfill orders without the risk of delays from subcontractors. This allows us to react promptly to customer needs and deliver products exactly when they are needed, adhering to the philosophy of JUST IN TIME delivery.

The future is us

In today's world, advanced technology and an experienced team are just the beginning. The secret to competitive advantage is the ability to integrate these two elements into a harmonious whole.

What sets ALSANIT apart from other companies is our innovative approach based on network-centric solutions. In practice, this means that information entered once is shared in real-time across various workstations. This accelerates processes, minimizes the risk of errors, and ensures consistency at every stage of operation.

At ALSANIT, we don't wait for the future – we create it.



DOOR-TO-DOOR DELIVERY

ALSANIT MANAGER

The ALSANIT MANAGER application is the digital essence of efficiency. It revolutionizes the way your order is processed. Designed and created internally by our IT team, it is evidence of our commitment to the latest technologies.

All our machines and workstations are integrated with an advanced information circulation system. The heart of this system is ALSANIT MANAGER, which provides us with real-time data at every stage of production.

This digital transparency guarantees us and our clients full awareness of the progress in project execution. This makes us not just a manufacturing company; we are pioneers in implementing modern IT solutions.

Delivery without compromise

At ALSANIT, we place great emphasis on the comfort of our customers. That's why we offer „door-to-door” delivery. This ensures that ordered products will arrive safely and intact to any location.

We strive to tailor each delivery precisely to the needs and expectations of our partners. For those who prefer their own transportation, we have prepared the option of personal pickup. Simply contact our logistics department in advance to arrange a convenient pick up time.

Full comfort of assembly service

At ALSANIT, we prioritize comprehensive services. In addition to delivering top-quality products, we also offer optional installation carried out by our authorized teams.

Our installation teams, equipped with specialized knowledge and practical experience, ensure precise and reliable service. This provides you with the assurance that ALSANIT products will be installed according to the highest industry standards.

Ecology

We respect nature in every action

ALSANIT is not just a business but also a responsible participant in the ecosystem. Understanding the importance of sustainable development runs through our entire operation - from product design to implementation. We don't limit ourselves to maintaining the environment around our company in a 'green' state. At every step, we prioritize the use of ecological materials and environmentally friendly technologies.

Our commitment to environmental protection is not a one-time effort. We systematically expand our knowledge in the field of eco-design, while also promoting an ecological approach among our clients. An example of our pro-environmental attitude is the implementation of solutions based on photovoltaic energy, which contributes significantly to reducing CO₂ emissions. We strive to become a role model in terms of ecological business practices.

We develop while caring for the environment

In our business strategy, we emphasize sustainable management and the best use of available resources. This approach is not only our choice but also our obligation to future generations.

We take pride in using materials that hold prestigious certifications such as FSC, PEFC, and GREENGUARD, indicating their minimal environmental impact. However, our innovation doesn't stop at materials.

The modern technologies we introduce into our production process ensure not only excellent product quality but also low energy consumption of our machinery.

By producing key components like fittings and accessories in-house, we significantly reduce our company's carbon footprint. But our eco-friendly efforts don't end there. The Sustainable Supplier certificate we possess underscores our commitment to responsible waste management - from creation to safe disposal. We act with ecological balance in mind, delivering products of the highest quality.

Three words of great significance

The principle of REUSE, RECYCLE, REDUCE has been accompanying ALSANIT since its inception.

REUSE - All our actions strive to maximize the use of materials generated during the production and cutting of our products.

RECYCLE - By avoiding the waste of potentially useful materials and reducing the consumption of available resources, we significantly reduce energy consumption, air pollution, and water pollution. Post-production waste, if it cannot be reused, is sorted and sent for specialized disposal.

REDUCE - The company's policy focuses on saving materials and, consequently, in the long term, reducing emissions.

ALSANIT places great emphasis on ecologically sustainable design of its products and the innovation of applied solutions. ALSANIT lockers, based on modular construction of the bodies, can be supplemented with accessories or have their configuration changed even after delivery to the customer. In this way, we significantly extend the product's lifecycle and truly reduce the amount of waste. This is how we believe true ecology should look like.





**WE HAVE PANELS COVERING 40%
OF ENERGY NEEDS**

AND LOCKERS AND BENCHES

When designing our lockers, we innovate to ensure our products set new trends and stay one step ahead of the competition.



Our patented modular locker system is one of the best in the world.

The COMBO lockers are the result of years of experience and creativity. They retain the lightweight metal body while the modular design significantly enhances their durability and allows for flexibility in terms of shape and color.



COMBO

COMBO

COMBO modular, hpl / mfc / glass doors

Body:

METAL - powder-coated galvanized steel

Doors:

HPL - High pressure laminate

MFC - Laminated Chipboard

GLASS - Tempered glass

Description:

The COMBO lockers combine the best features of products available on the market. They have the lightness typical of metal bodies, while the doors, being the most exposed to wear, are made of durable materials.

The locker bodies are always made of galvanized steel, coated with powder paint. The doors use materials available in various decors and structures, allowing for the creation of unique designs.

Thanks to the patented modular construction, the possibilities for locker applications are practically limitless. The body can be customized even after delivery to the destination. Changes to the interior equipment, dimensions, opening direction, and even door material are possible.

Combining durability with elegance and competitive pricing - COMBO lockers are, in our opinion, the perfect choice.



page 96 →



Patent
P.434877 (lockers)
Protected design
WP.30407 (hinge)

 only Torx screws are used

 fully assembled product

 the possibility of custom built

 easy to clean



Quality confirmed by certificates

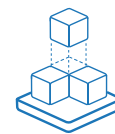

Flexibility for changes at any time



Even gaps between the doors



Frontlaying doors



Eco-design according to the concept of REUSE

Standard dimensions

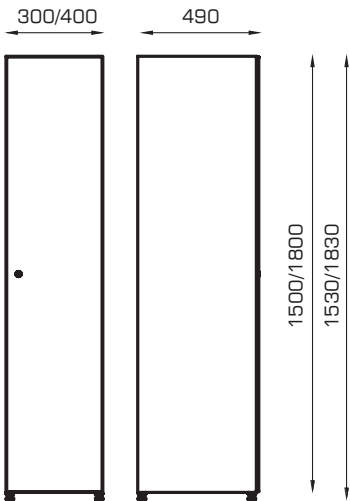

Base options

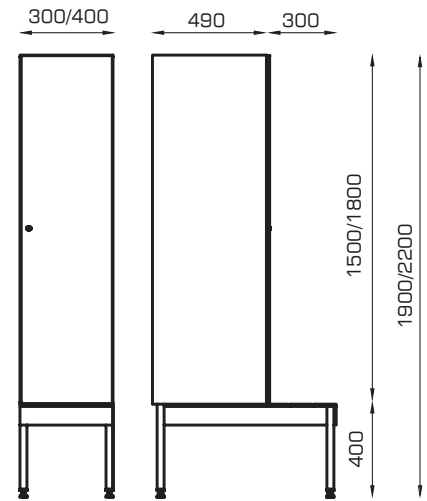
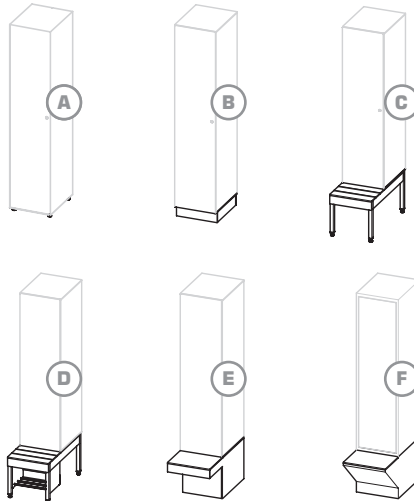

Standard equipment

patented hinge
manufactured by ALSANIT



stable, aluminum rod
and durable hooks
manufactured by ALSANIT



as a standard - key lock
or a padlock



the door in the selected variant:
HPL 10/12 mm, **MFC** 18 mm, **GLASS** 6 mm

the body and back made of galvanized steel:
0.7 mm powder-coated

adjustable leg



available additional
options

[page 90](#) →

available lock
options

[page 92](#) →

available
colors

[page 173](#) →



COMBO modular, hpl / mfc / glass doors



Single-level lockers

Doors available in:

MFC HPL GLASS

STANDARD VERSION



DIMENSIONS	PRODUCT CODE	CD-15311-01	CD-15411-01	CD-15321-01	CD-15421-01	CD-15331-01	CD-15431-01	CD-15341-01	-
	HEIGHT	1500	1500	1500	1500	1500	1500	1500	-
	PRODUCT CODE	CD-18311-01	CD-18411-01	CD-18321-01	CD-18421-01	CD-18331-01	CD-18431-01	CD-18341-01	-
	HEIGHT	1800	1800	1800	1800	1800	1800	1800	-
	OVERALL WIDTH	300	400	600	800	900	1200	1200	-
	COLUMN WIDTH	1X300	1X400	2X300	2X400	3X300	3X400	4X300	-
	DEPTH	490	490	490	490	490	490	490	-
EQUIPMENT	LEGS HEIGHT 30	✓	✓	✓	✓	✓	✓	✓	-
	SHELF	✓	✓	✓	✓	✓	✓	✓	-
	BAR WITH HOOKS	✓	✓	✓	✓	✓	✓	✓	-
	CLOTHING HOOK	✓	✓	✓	✓	✓	✓	✓	-
	KEY LOCK	✓	✓	✓	✓	✓	✓	✓	-
	PADLOCK LOCK	✓	✓	✓	✓	✓	✓	✓	-

+	TYPES OF LOCKS	AVAILABLE TYPES OF LOCKS: PAGE 92
	ADDITIONAL OPTIONS	AVAILABLE ADDITIONAL OPTIONS: PAGE 90
	COLOR OPTIONS	AVAILABLE COLOR OPTIONS: PAGE 173

COMBO

Two-level lockers

Doors available in:

- MFC
- HPL
- GLASS

STANDARD VERSION



DIMENSIONS	PRODUCT CODE	CD-15312-01	CD-15412-01	CD-15322-01	CD-15422-01	CD-15332-01	CD-15432-01	CD-15342-01	-
	HEIGHT	1500	1500	1500	1500	1500	1500	1500	-
	PRODUCT CODE	CD-18312-01	CD-18412-01	CD-18322-01	CD-18422-01	CD-18332-01	CD-18432-01	CD-18342-01	-
	HEIGHT	1800	1800	1800	1800	1800	1800	1800	-
	OVERALL WIDTH	300	400	600	800	900	1200	1200	-
	COLUMN WIDTH	1X300	1X400	2X300	2X400	3X300	3X400	4X300	-
	DEPTH	490	490	490	490	490	490	490	-
EQUIPMENT	LEGS HEIGHT 30	✓	✓	✓	✓	✓	✓	✓	-
	SHELF	✓	✓	✓	✓	✓	✓	✓	-
	BAR WITH HOOKS	✓	✓	✓	✓	✓	✓	✓	-
	CLOTHING HOOK	✓	✓	✓	✓	✓	✓	✓	-
	KEY LOCK	✓	✓	✓	✓	✓	✓	✓	-
	PADLOCK LOCK	✓	✓	✓	✓	✓	✓	✓	-

+ **TYPES OF LOCKS** AVAILABLE TYPES OF LOCKS: PAGE 92
ADDITIONAL OPTIONS AVAILABLE ADDITIONAL OPTIONS: PAGE 90
COLOR OPTIONS AVAILABLE COLOR OPTIONS: PAGE 173

COMBO

modular, hpl / mfc / glass doors

Three-level lockers

Doors available in:

MFC HPL GLASS

STANDARD VERSION



DIMENSIONS	PRODUCT CODE	CD-15313-00	CD-15413-00	CD-15323-00	CD-15423-00	CD-15333-00	CD-15433-00	CD-15343-00	-
	HEIGHT	1500	1500	1500	1500	1500	1500	1500	-
	PRODUCT CODE	CD-18313-00	CD-18413-00	CD-18323-00	CD-18423-00	CD-18333-00	CD-18433-00	CD-18343-00	-
	HEIGHT	1800	1800	1800	1800	1800	1800	1800	-
	OVERALL WIDTH	300	400	600	800	900	1200	1200	-
	COLUMN WIDTH	1X300	1X400	2X300	2X400	3X300	3X400	4X300	-
DEPTH	490	490	490	490	490	490	490	-	
EQUIPMENT	LEGS HEIGHT 30	✓	✓	✓	✓	✓	✓	✓	-
	SHELF	-	-	-	-	-	-	-	-
	BAR WITH HOOKS	-	-	-	-	-	-	-	-
	CLOTHING HOOK	✓	✓	✓	✓	✓	✓	✓	-
	KEY LOCK	✓	✓	✓	✓	✓	✓	✓	-
	PADLOCK LOCK	✓	✓	✓	✓	✓	✓	✓	-

+	TYPES OF LOCKS	AVAILABLE TYPES OF LOCKS: PAGE 92
	ADDITIONAL OPTIONS	AVAILABLE ADDITIONAL OPTIONS: PAGE 90
	COLOR OPTIONS	AVAILABLE COLOR OPTIONS: PAGE 173

Five-level lockers

Doors available in:

MFC HPL GLASS

STANDARD VERSION



DIMENSIONS	PRODUCT CODE	CD-15315-00	CD-15415-00	CD-15325-00	CD-15425-00	CD-15335-00	CD-15435-00	CD-15345-00	-
	HEIGHT	1500	1500	1500	1500	1500	1500	1500	-
	PRODUCT CODE	CD-18315-00	CD-18415-00	CD-18325-00	CD-18425-00	CD-18335-00	CD-18435-00	CD-18345-00	-
	HEIGHT	1800	1800	1800	1800	1800	1800	1800	-
	OVERALL WIDTH	300	400	600	800	900	1200	1200	-
	COLUMN WIDTH	1X300	1X400	2X300	2X400	3X300	3X400	4X300	-
DEPTH	490	490	490	490	490	490	490	-	
EQUIPMENT	LEGS HEIGHT 30	✓	✓	✓	✓	✓	✓	✓	-
	SHELF	-	-	-	-	-	-	-	-
	BAR WITH HOOKS	-	-	-	-	-	-	-	-
	CLOTHING HOOK	-	-	-	-	-	-	-	-
	KEY LOCK	✓	✓	✓	✓	✓	✓	✓	-
	PADLOCK LOCK	✓	✓	✓	✓	✓	✓	✓	-

+	TYPES OF LOCKS	AVAILABLE TYPES OF LOCKS: PAGE 92
	ADDITIONAL OPTIONS	AVAILABLE ADDITIONAL OPTIONS: PAGE 90
	COLOR OPTIONS	AVAILABLE COLOR OPTIONS: PAGE 173

Four-level lockers

Doors available in:

- MFC HPL GLASS

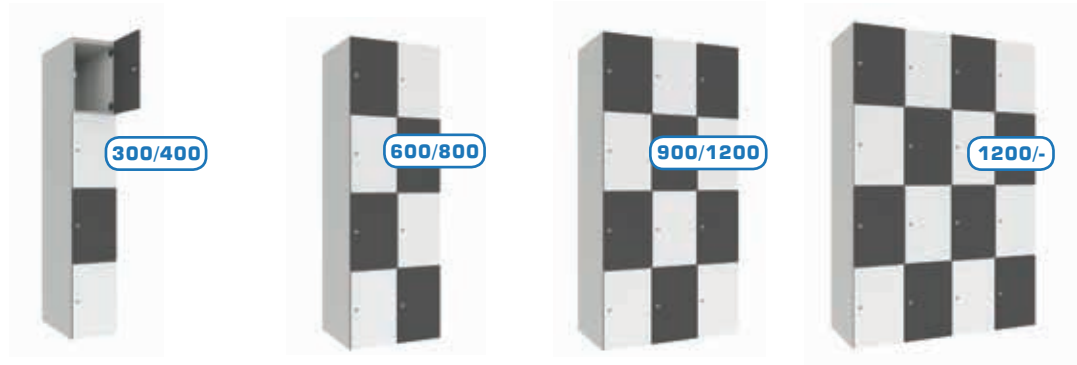

STANDARD VERSION

DIMENSIONS	PRODUCT CODE	CD-15314-00	CD-15414-00	CD-15324-00	CD-15424-00	CD-15334-00	CD-15434-00	CD-15344-00	-
	HEIGHT	1500	1500	1500	1500	1500	1500	1500	-
	PRODUCT CODE	CD-18314-00	CD-18414-00	CD-18324-00	CD-18424-00	CD-18334-00	CD-18434-00	CD-18344-00	-
	HEIGHT	1800	1800	1800	1800	1800	1800	1800	-
	OVERALL WIDTH	300	400	600	800	900	1200	1200	-
	COLUMN WIDTH	1X300	1X400	2X300	2X400	3X300	3X400	4X300	-
DEPTH	490	490	490	490	490	490	490	-	
EQUIPMENT	LEGS HEIGHT 30	✓	✓	✓	✓	✓	✓	✓	-
	SHELF	-	-	-	-	-	-	-	-
	BAR WITH HOOKS	-	-	-	-	-	-	-	-
	CLOTHING HOOK	-	-	-	-	-	-	-	-
	KEY LOCK	✓	✓	✓	✓	✓	✓	✓	-
	PADLOCK LOCK	✓	✓	✓	✓	✓	✓	✓	-

+	TYPES OF LOCKS	AVAILABLE TYPES OF LOCKS: PAGE 92
	ADDITIONAL OPTIONS	AVAILABLE ADDITIONAL OPTIONS: PAGE 90
	COLOR OPTIONS	AVAILABLE COLOR OPTIONS: PAGE 173

Clothing lockers L

Doors available in:

- HPL GLASS



STANDARD VERSION

DIMENSIONS	PRODUCT CODE	CZ-15312-00	CZ-15412-00	CZ-15322-00	CZ-15422-00	CZ-15332-00	CZ-15432-00	CZ-15342-00	-
	HEIGHT	1500	1500	1500	1500	1500	1500	1500	-
	PRODUCT CODE	CZ-18312-00	CZ-18412-00	CZ-18322-00	CZ-18422-00	CZ-18332-00	CZ-18432-00	CZ-18342-00	-
	HEIGHT	1800	1800	1800	1800	1800	1800	1800	-
	OVERALL WIDTH	300	400	600	800	900	1200	1200	-
	COLUMN WIDTH	1X300	1X400	2X300	2X400	3X300	3X400	4X300	-
DEPTH	490	490	490	490	490	490	490	-	
EQUIPMENT	LEGS HEIGHT 30	✓	✓	✓	✓	✓	✓	✓	-
	SHELF	-	-	-	-	-	-	-	-
	BAR WITH HOOKS	✓	✓	✓	✓	✓	✓	✓	-
	CLOTHING HOOK	✓	✓	✓	✓	✓	✓	✓	-
	KEY LOCK	✓	✓	✓	✓	✓	✓	✓	-
	PADLOCK LOCK	✓	✓	✓	✓	✓	✓	✓	-

+	TYPES OF LOCKS	AVAILABLE TYPES OF LOCKS: PAGE 92
	ADDITIONAL OPTIONS	AVAILABLE ADDITIONAL OPTIONS: PAGE 90
	COLOR OPTIONS	AVAILABLE COLOR OPTIONS: PAGE 173



Patented modular construction - a worldwide innovation.

Modular construction means that the equipment, and thus the functions that the locker serves, can be changed over time. Therefore, it is a very economical solution in the longer term.

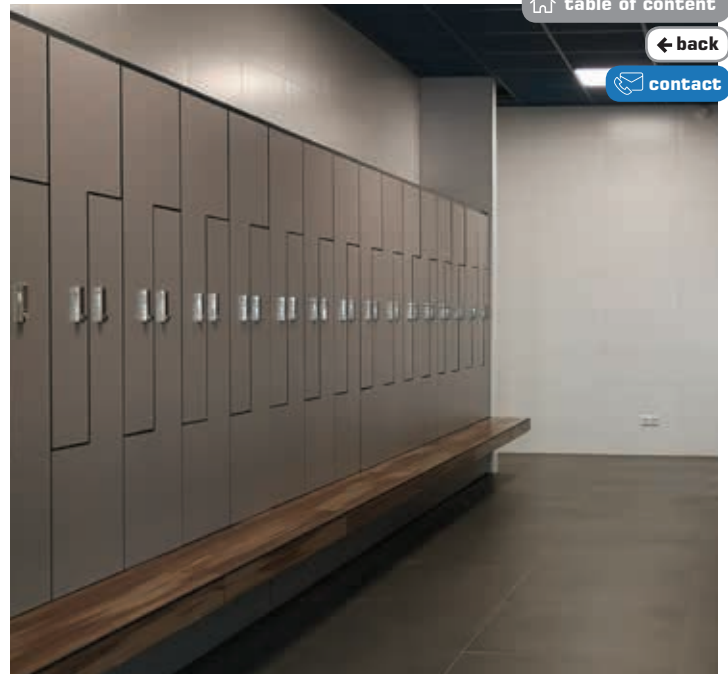



The concept of REUSE - redefining ecology.

Thanks to the possibility of adapting lockers according to needs instead of replacing them with new ones, it's possible to customize the current ones. This is achievable, among other things, due to galvanized bodies, which significantly increase the lifespan of the product.

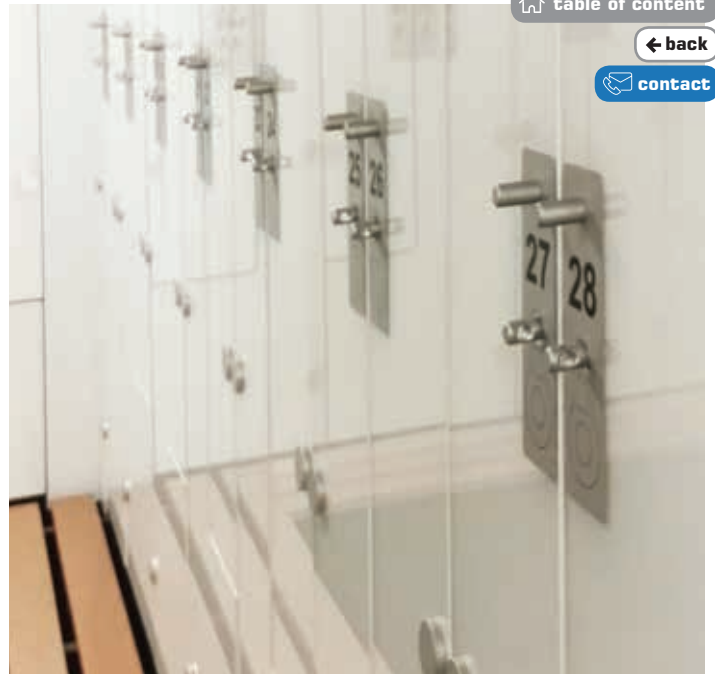

Doors available in multiple materials.

Thanks to the fact that the fronts can be made of HPL, GLASS, METAL or MFC, they will perfectly fit the style and budget of any investment.







HPL series TAURUS lockers are a revolution in the world of clothing lockers.

Extremely durable, easy to maintain. Available in natural decors and textures such as stone, concrete or wood.

[table of content](#)

[← back](#)

[contact](#)



TAURUS

TAURUS

TAURUS HPL lockers

Body:

HPL - High pressure laminate

Doors:

HPL - High pressure laminate

Description:

HPL panels are a modern material of the 21st century, characterized by exceptional durability, waterproof properties, and antibacterial features. When investing in clothing lockers, customers expect years of durability, and no other material provides such excellent longevity and functionality.

HPL lockers perform exceptionally well in extreme conditions, for example, in food processing plants or swimming pools, where aggressive environments and con-

tinuous user rotation cause high impact on the lockers.

HPL panels are offered in natural decors and textures such as stone, concrete, or wood, allowing for the creation of unique compositions.







TAURUS lockers, extremely durable and easy to maintain, are custom-made at no extra charge. To learn more, please contact us. Choosing HPL lockers from ALSANIT guarantees satisfaction.

 Prepared for **Smart Locker**

page 96 →



Protected design
WP.30407 (hinge)

-  only Torx screws are used
-  fully assembled product
-  the possibility of custom built
-  smooth inner walls
-  custom sizing available
-  easy to clean



Quality confirmed by certificates



100% waterproof



Even gaps between the doors



Frontlaying doors



The most durable on the market



Antibacterial and antifungal properties

Standard dimensions

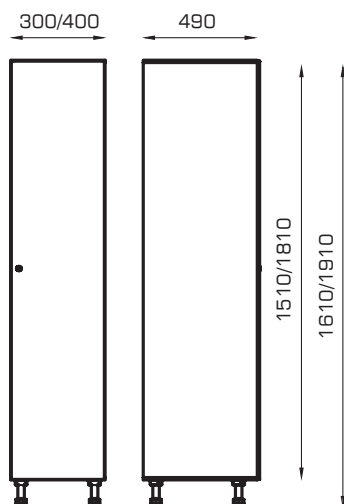

Base options

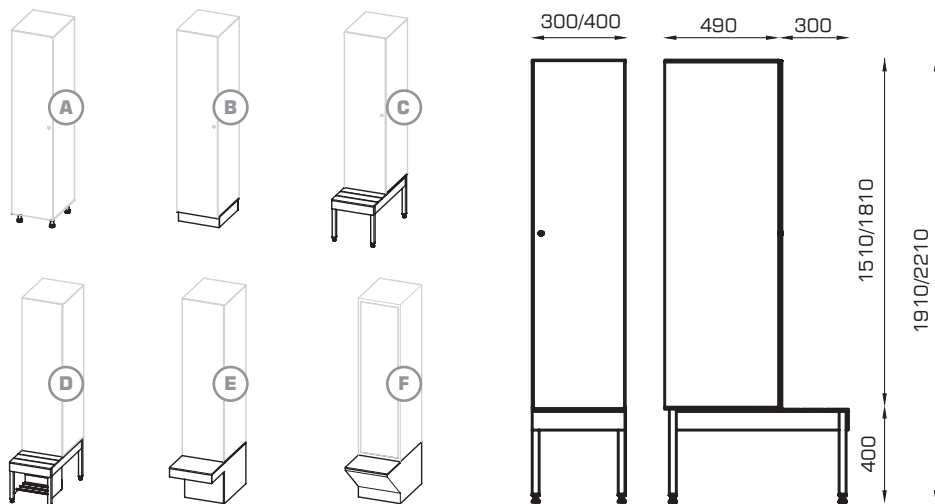

Standard equipment

patented hinge
manufactured by ALSANIT



stable, aluminum rod
and durable hooks
manufactured by ALSANIT

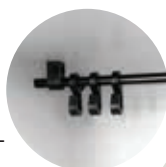

as a standard - key lock
or a padlock



doors: HPL 10/12 mm

body: HPL 10 mm
back: HPL 4 mm

polyamide leg

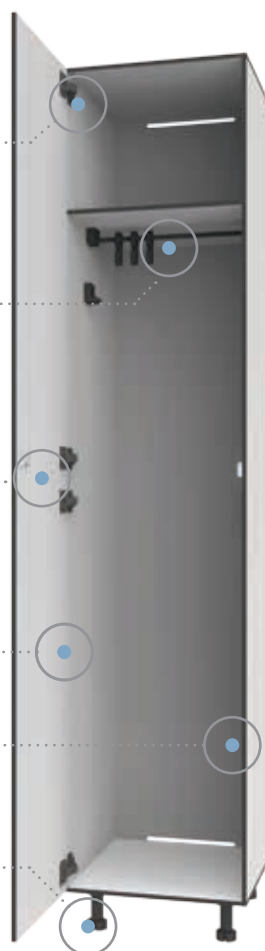

available additional
options

[page 90](#) →

available lock
options

[page 92](#) →

available
colors

[page 173](#) →



TAURUS HPL lockers



Single-level lockers



STANDARD VERSION

DIMENSIONS	PRODUCT CODE	TD-15311-01	TD-15411-01	TD-15321-01	TD-15421-01	TD-15331-01	TD-15431-01	TD-15341-01	-
	HEIGHT	1510	1510	1510	1510	1510	1510	1510	-
	PRODUCT CODE	TD-18311-01	TD-18411-01	TD-18321-01	TD-18421-01	TD-18331	TD-18431-01	TD-18341-01	-
	HEIGHT	1810	1810	1810	1810	1810	1810	1810	-
	OVERALL WIDTH	300	400	600	800	900	1200	1200	-
	COLUMN WIDTH	1X300	1X400	2X300	2X400	3X300	3X400	4X300	-
	DEPTH	490	490	490	490	490	490	490	-
EQUIPMENT	LEGS HEIGHT 100	✓	✓	✓	✓	✓	✓	✓	-
	SHELF	✓	✓	✓	✓	✓	✓	✓	-
	BAR WITH HOOKS	✓	✓	✓	✓	✓	✓	✓	-
	CLOTHING HOOK	✓	✓	✓	✓	✓	✓	✓	-
	KEY LOCK	✓	✓	✓	✓	✓	✓	✓	-
	PADLOCK LOCK	✓	✓	✓	✓	✓	✓	✓	-
+	TYPES OF LOCKS	AVAILABLE TYPES OF LOCKS: PAGE 92							
	ADDITIONAL OPTIONS	AVAILABLE ADDITIONAL OPTIONS: PAGE 90							
	COLOR OPTIONS	AVAILABLE COLOR OPTIONS: PAGE 173							

TAURUS

Two-level lockers



STANDARD VERSION

DIMENSIONS	PRODUCT CODE	TD-15312-01	TD-15412-01	TD-15322-01	TD-15422-01	TD-15332-01	TD-15432-01	TD-15342-01	-
	HEIGHT	1510	1510	1510	1510	1510	1510	1510	-
	PRODUCT CODE	TD-18312-01	TD-18412-01	TD-18322-01	TD-18422-01	TD-18332-01	TD-18432-01	TD-18342-01	-
	HEIGHT	1810	1810	1810	1810	1810	1810	1810	-
	OVERALL WIDTH	300	400	600	800	900	1200	1200	-
	COLUMN WIDTH	1X300	1X400	2X300	2X400	3X300	3X400	4X300	-
	DEPTH	490	490	490	490	490	490	490	-
EQUIPMENT	LEGS HEIGHT 100	✓	✓	✓	✓	✓	✓	✓	-
	SHELF	✓	✓	✓	✓	✓	✓	✓	-
	BAR WITH HOOKS	✓	✓	✓	✓	✓	✓	✓	-
	CLOTHING HOOK	✓	✓	✓	✓	✓	✓	✓	-
	KEY LOCK	✓	✓	✓	✓	✓	✓	✓	-
	PADLOCK LOCK	✓	✓	✓	✓	✓	✓	✓	-

+	TYPES OF LOCKS	AVAILABLE TYPES OF LOCKS: PAGE 92
	ADDITIONAL OPTIONS	AVAILABLE ADDITIONAL OPTIONS: PAGE 90
	COLOR OPTIONS	AVAILABLE COLOR OPTIONS: PAGE 173

TAURUS HPL lockers

Three-level lockers



STANDARD VERSION

DIMENSIONS	PRODUCT CODE	TD-15313-00	TD-15413-00	TD-15323-00	TD-15423-00	TD-15333-00	TD-15433-00	TD-15343-00	-
	HEIGHT	1510	1510	1510	1510	1510	1510	1510	-
	PRODUCT CODE	TD-18313-00	TD-18413-00	TD-18323-00	TD-18423-00	TD-18333-00	TD-18433-00	TD-18343-00	-
	HEIGHT	1810	1810	1810	1810	1810	1810	1810	-
	OVERALL WIDTH	300	400	600	800	900	1200	1200	-
	COLUMN WIDTH	1X300	1X400	2X300	2X400	3X300	3X400	4X300	-
DEPTH	490	490	490	490	490	490	490	-	
EQUIPMENT	LEGS HEIGHT 100	✓	✓	✓	✓	✓	✓	✓	-
	SHELF	-	-	-	-	-	-	-	-
	BAR WITH HOOKS	-	-	-	-	-	-	-	-
	CLOTHING HOOK	✓	✓	✓	✓	✓	✓	✓	-
	KEY LOCK	✓	✓	✓	✓	✓	✓	✓	-
PADLOCK LOCK	✓	✓	✓	✓	✓	✓	✓	-	
+	TYPES OF LOCKS	AVAILABLE TYPES OF LOCKS: PAGE 92							
	ADDITIONAL OPTIONS	AVAILABLE ADDITIONAL OPTIONS: PAGE 90							
	COLOR OPTIONS	AVAILABLE COLOR OPTIONS: PAGE 173							

Five-level lockers



STANDARD VERSION

DIMENSIONS	PRODUCT CODE	TD-15315-00	TD-15415-00	TD-15325-00	TD-15425-00	TD-15335-00	TD-15435-00	TD-15345-00	-
	HEIGHT	1510	1510	1510	1510	1510	1510	1510	-
	PRODUCT CODE	TD-18315-00	TD-18415-00	TD-18325-00	TD-18425-00	TD-18335-00	TD-18435-00	TD-18345-00	-
	HEIGHT	1810	1810	1810	1810	1810	1810	1810	-
	OVERALL WIDTH	300	400	600	800	900	1200	1200	-
	COLUMN WIDTH	1X300	1X400	2X300	2X400	3X300	3X400	4X300	-
DEPTH	490	490	490	490	490	490	490	-	
EQUIPMENT	LEGS HEIGHT 100	✓	✓	✓	✓	✓	✓	✓	-
	SHELF	-	-	-	-	-	-	-	-
	BAR WITH HOOKS	-	-	-	-	-	-	-	-
	CLOTHING HOOK	-	-	-	-	-	-	-	-
	KEY LOCK	✓	✓	✓	✓	✓	✓	✓	-
PADLOCK LOCK	✓	✓	✓	✓	✓	✓	✓	-	
+	TYPES OF LOCKS	AVAILABLE TYPES OF LOCKS: PAGE 92							
	ADDITIONAL OPTIONS	AVAILABLE ADDITIONAL OPTIONS: PAGE 90							
	COLOR OPTIONS	AVAILABLE COLOR OPTIONS: PAGE 173							

Four-level lockers



STANDARD VERSION

DIMENSIONS	PRODUCT CODE	TD-15314-00	TD-15414-00	TD-15324-00	TD-15424-00	TD-15334-00	TD-15434-00	TD-15344-00	-
	HEIGHT	1510	1510	1510	1510	1510	1510	1510	-
	PRODUCT CODE	TD-18314-00	TD-18414-00	TD-18324-00	TD-18424-00	TD-18334-00	TD-18434-00	TD-18344-00	-
	HEIGHT	1810	1810	1810	1810	1810	1810	1810	-
	OVERALL WIDTH	300	400	600	800	900	1200	1200	-
	COLUMN WIDTH	1X300	1X400	2X300	2X400	3X300	3X400	4X300	-
	DEPTH	490	490	490	490	490	490	490	-
EQUIPMENT	LEGS HEIGHT 100	✓	✓	✓	✓	✓	✓	✓	-
	SHELF	-	-	-	-	-	-	-	-
	BAR WITH HOOKS	-	-	-	-	-	-	-	-
	CLOTHING HOOK	-	-	-	-	-	-	-	-
	KEY LOCK	✓	✓	✓	✓	✓	✓	✓	-
	PADLOCK LOCK	✓	✓	✓	✓	✓	✓	✓	-

+	TYPES OF LOCKS	AVAILABLE TYPES OF LOCKS: PAGE 92
	ADDITIONAL OPTIONS	AVAILABLE ADDITIONAL OPTIONS: PAGE 90
	COLOR OPTIONS	AVAILABLE COLOR OPTIONS: PAGE 173

Clothing lockers L



STANDARD VERSION

DIMENSIONS	PRODUCT CODE	TZ-15312-00	TZ-15412-00	TZ-15322-00	TZ-15422-00	TZ-15332-00	TZ-15432-00	TZ-15342-00	-
	HEIGHT	1510	1510	1510	1510	1510	1510	1510	-
	PRODUCT CODE	TZ-18312-00	TZ-18412-00	TZ-18322-00	TZ-18422-00	TZ-18332-00	TZ-18432-00	TZ-18342-00	-
	HEIGHT	1810	1810	1810	1810	1810	1810	1810	-
	OVERALL WIDTH	300	400	600	800	900	1200	1200	-
	COLUMN WIDTH	1X300	1X400	2X300	2X400	3X300	3X400	4X300	-
	DEPTH	490	490	490	490	490	490	490	-
EQUIPMENT	LEGS HEIGHT 100	✓	✓	✓	✓	✓	✓	✓	-
	SHELF	-	-	-	-	-	-	-	-
	BAR WITH HOOKS	✓	✓	✓	✓	✓	✓	✓	-
	CLOTHING HOOK	✓	✓	✓	✓	✓	✓	✓	-
	KEY LOCK	✓	✓	✓	✓	✓	✓	✓	-
	PADLOCK LOCK	✓	✓	✓	✓	✓	✓	✓	-

+	TYPES OF LOCKS	AVAILABLE TYPES OF LOCKS: PAGE 92
	ADDITIONAL OPTIONS	AVAILABLE ADDITIONAL OPTIONS: PAGE 90
	COLOR OPTIONS	AVAILABLE COLOR OPTIONS: PAGE 173



HPL lockers, initially used exclusively in swimming pools, are now in common use.

We are the largest manufacturer of HPL lockers in Poland. Thanks to our acquired experience, our furniture is perfected in every detail.

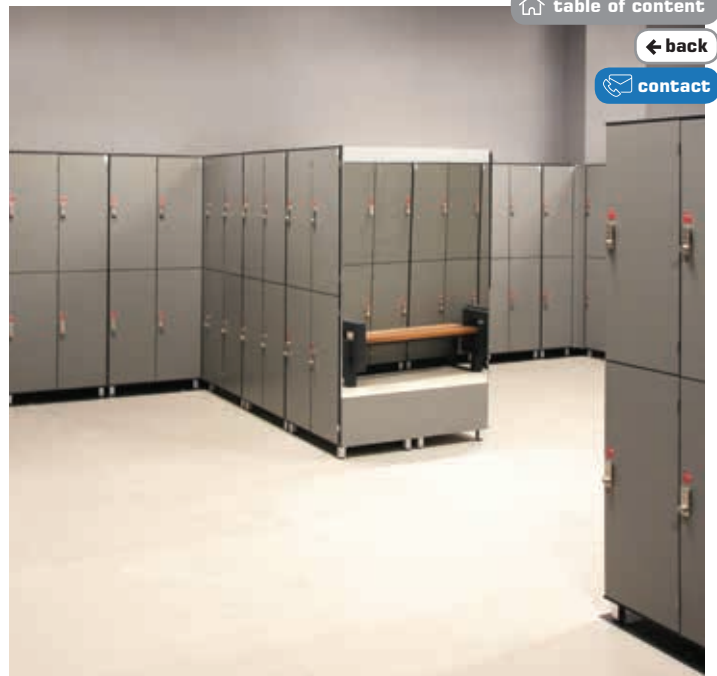

In-house accessories and fittings for lockers.

Since we design and manufacture accessories and fittings for lockers ourselves, we have confidence in their highest quality and durability.



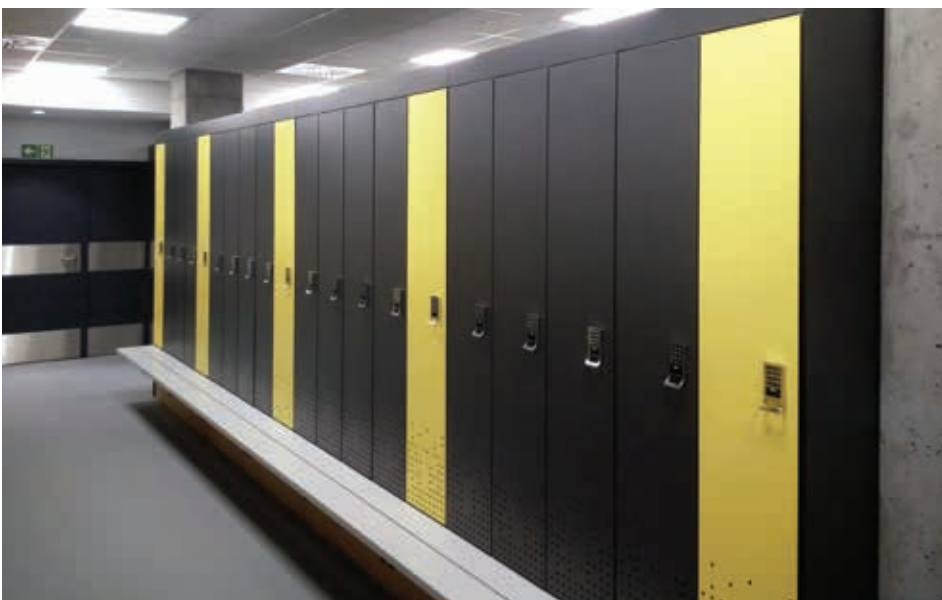
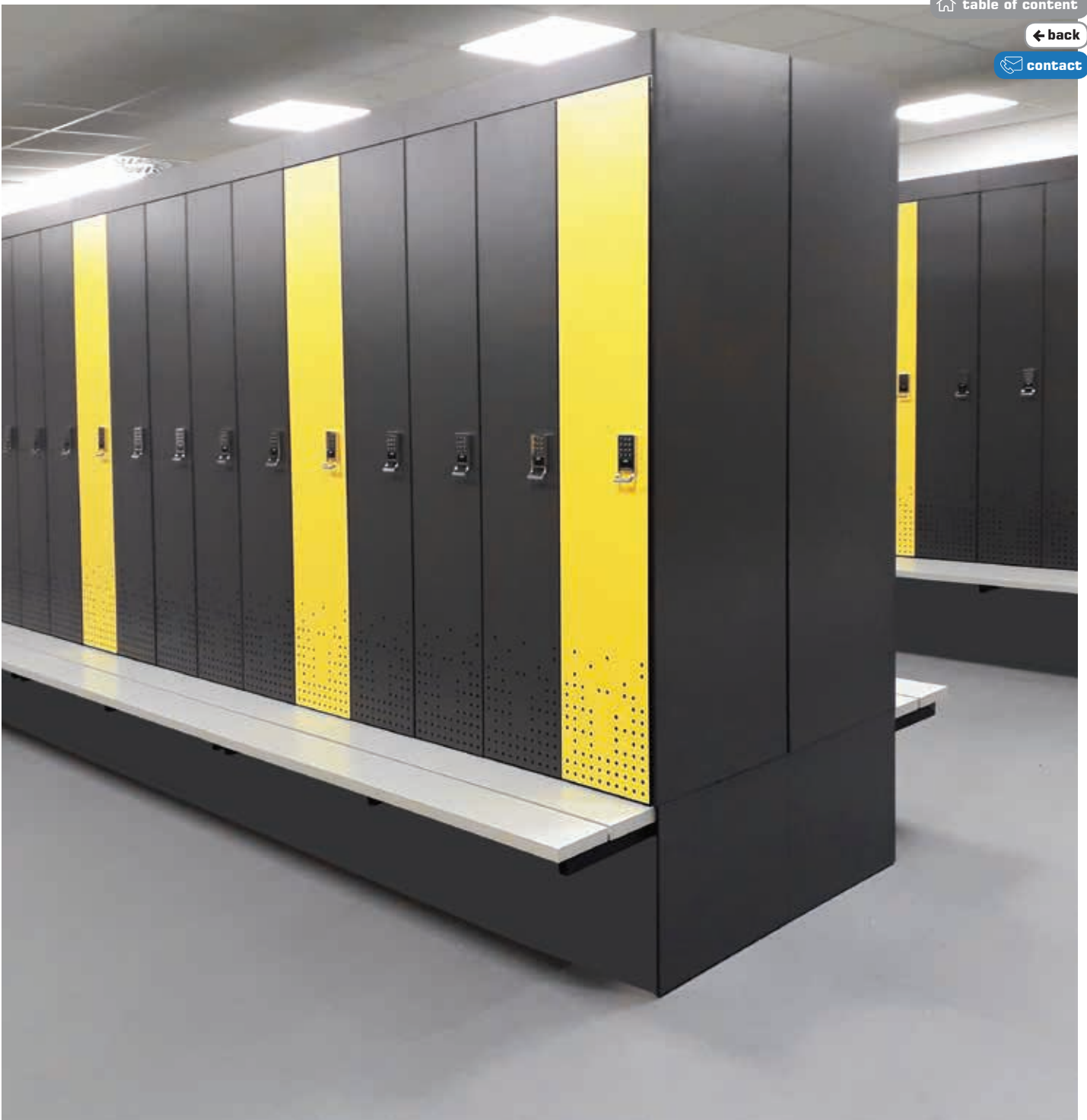

Antibacterial properties of HPL.

Due to the standard antibacterial and antifungal properties of HPL panels, they are perfect for industries such as pharmaceuticals or food processing.





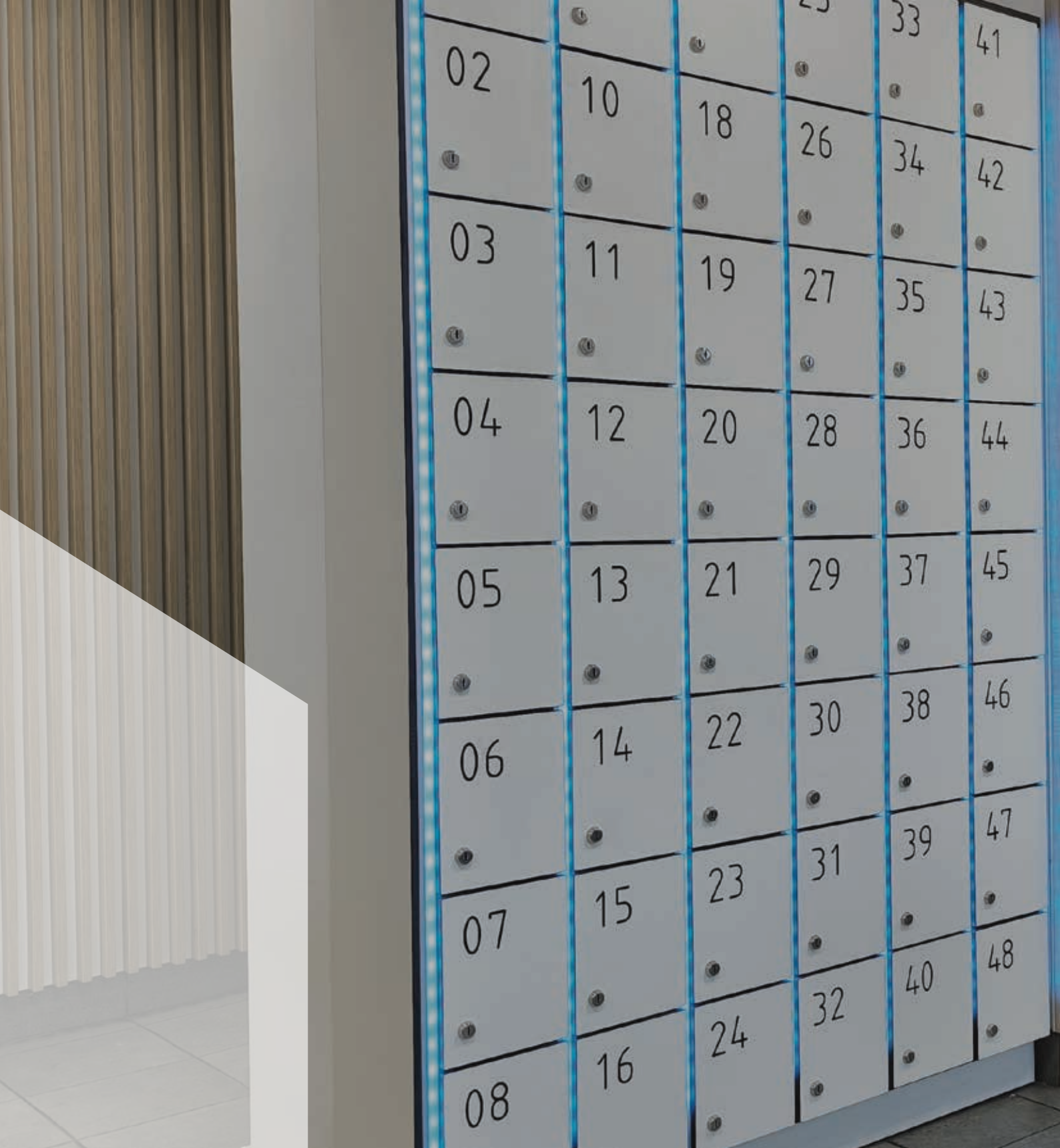

Lockers made of HPL, which construction is made using patented system of aluminum profiles.

ARTUS lockers ensure strength and durability for many years, while maintaining a modern look and functionality.



ARTUS

ARTUS

ARTUS HPL lockers on profiles

Body:

HPL - High pressure laminate
ALUMINUM - Anodized aluminum profiles

Doors:

HPL - High pressure laminate

Description:

ARTUS series lockers are distinguished by specially designed structural profiles. They allow for the installation of additional options:

- AQUARI hinges that open at 180 degrees and allow for the construction of PIANO doors,
- LED lighting, which gives the lockers a modern and eye-catching character. The mounting socket for these elements if not used is discreetly hidden behind an elegant aluminum cover.

Thanks to innovative solutions, these

lockers offer the possibility of configuration to any dimension, maximally meeting individual needs.

Although initially HPL lockers were intended for use in swimming pools, their excellent properties have led to their application in many other facilities.

Investing in ARTUS lockers is a choice of uncompromising quality. Designed for durability, functionality and elegant appearance, they prove that excellence is within reach of each of our customers.

 Prepared for
Smart Locker

page 96 →



Patents:
P.220888 (profile system)
P.425699 (hidden hinge)
Protected design:
WR.30407 (hinge)

 only Torx screws are used

 fully assembled product

 custom sizing available

 the possibility of custom built

 easy to clean



Patented profile system



**Piano door option
„Finger-safe”**

page 54 →



**Option to use LED
lighting**



Frontlaying doors



100% waterproof



**Antibacterial and
antifungal properties**

Standard dimensions

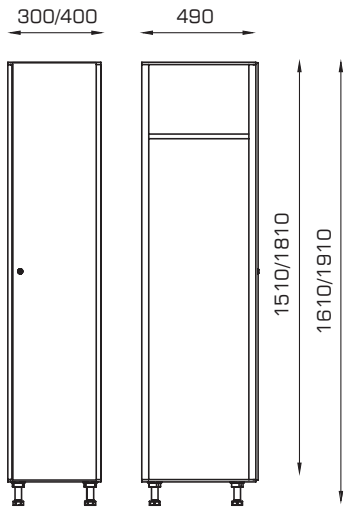

Base options

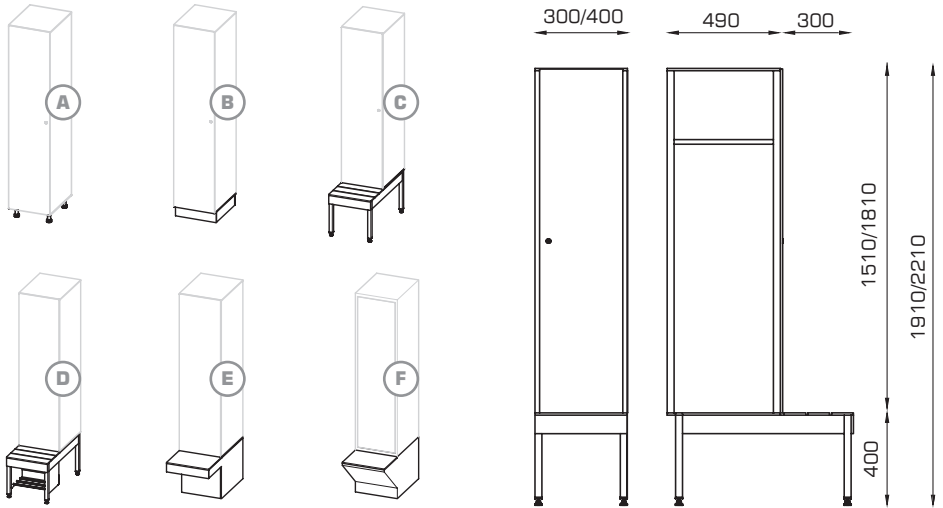

Standard equipment

patented hinge
manufactured by ALSANIT



stable, aluminum rod
and durable hooks
manufactured by ALSANIT

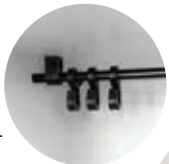

as a standard - key lock
or a padlock



doors: HPL 10/12 mm

body and back: HPL 4 mm

polyamide leg



available additional
options

[page 90](#) →

available lock
options

[page 92](#) →

available
colors

[page 173](#) →



ARTUS HPL lockers on profiles



Single-level lockers



STANDARD VERSION

DIMENSIONS	PRODUCT CODE	AD-15311-01	AD-15411-01	AD-15321-01	AD-15421-01	AD-15331-01	AD-15431-01	AD-15341-01	-
	HEIGHT	1510	1510	1510	1510	1510	1510	1510	-
	PRODUCT CODE	AD-18311-01	AD-18411-01	AD-18321-01	AD-18421-01	AD-18331-01	AD-18431-01	AD-18341-01	-
	HEIGHT	1810	1810	1810	1810	1810	1810	1810	-
	OVERALL WIDTH	300	400	600	800	900	1200	1200	-
	COLUMN WIDTH	1X300	1X400	2X300	2X400	3X300	3X400	4X300	-
	DEPTH	490	490	490	490	490	490	490	-
EQUIPMENT	LEGS HEIGHT 100	✓	✓	✓	✓	✓	✓	✓	-
	SHELF	✓	✓	✓	✓	✓	✓	✓	-
	BAR WITH HOOKS	✓	✓	✓	✓	✓	✓	✓	-
	CLOTHING HOOK	✓	✓	✓	✓	✓	✓	✓	-
	KEY LOCK	✓	✓	✓	✓	✓	✓	✓	-
	PADLOCK LOCK	✓	✓	✓	✓	✓	✓	✓	-
+	TYPES OF LOCKS	AVAILABLE TYPES OF LOCKS: PAGE 92							
	ADDITIONAL OPTIONS	AVAILABLE ADDITIONAL OPTIONS: PAGE 90							
	COLOR OPTIONS	AVAILABLE COLOR OPTIONS: PAGE 173							

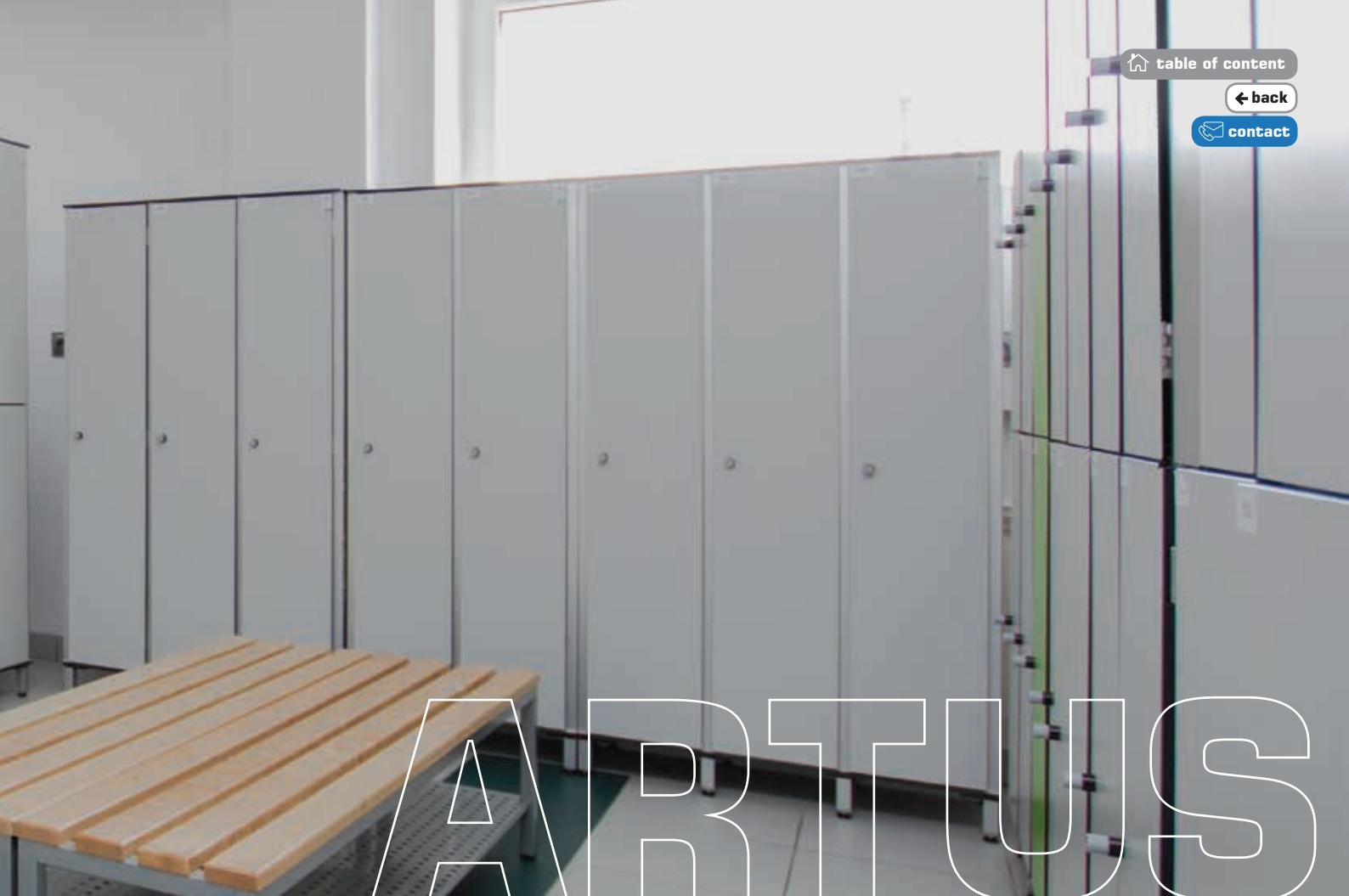

Two-level lockers



STANDARD VERSION

DIMENSIONS	PRODUCT CODE	AD-15312-01	AD-15412-01	AD-15322-01	AD-15422-01	AD-15332-01	AD-15432-01	AD-15342-01	-
	HEIGHT	1510	1510	1510	1510	1510	1510	1510	-
	PRODUCT CODE	AD-18312-01	AD-18412-01	AD-18322-01	AD-18422-01	AD-18332-01	AD-18432-01	AD-18342-01	-
	HEIGHT	1810	1810	1810	1810	1810	1810	1810	-
	OVERALL WIDTH	300	400	600	800	900	1200	1200	-
	COLUMN WIDTH	1X300	1X400	2X300	2X400	3X300	3X400	4X300	-
	DEPTH	490	490	490	490	490	490	490	-
EQUIPMENT	LEGS HEIGHT 100	✓	✓	✓	✓	✓	✓	✓	-
	SHELF	✓	✓	✓	✓	✓	✓	✓	-
	BAR WITH HOOKS	✓	✓	✓	✓	✓	✓	✓	-
	CLOTHING HOOK	✓	✓	✓	✓	✓	✓	✓	-
	KEY LOCK	✓	✓	✓	✓	✓	✓	✓	-
	PADLOCK LOCK	✓	✓	✓	✓	✓	✓	✓	-

+	TYPES OF LOCKS	AVAILABLE TYPES OF LOCKS: PAGE 92
	ADDITIONAL OPTIONS	AVAILABLE ADDITIONAL OPTIONS: PAGE 90
	COLOR OPTIONS	AVAILABLE COLOR OPTIONS: PAGE 173

ARTUS HPL lockers on profiles

Three-level lockers



STANDARD VERSION

DIMENSIONS	PRODUCT CODE	AD-15313-00	AD-15413-00	AD-15323-00	AD-15423-00	AD-15333-00	AD-15433-00	AD-15343-00	-
	HEIGHT	1510	1510	1510	1510	1510	1510	1510	-
	PRODUCT CODE	AD-18313-00	AD-18413-00	AD-18323-00	AD-18423-00	AD-18333-00	AD-18433-00	AD-18343-00	-
	HEIGHT	1810	1810	1810	1810	1810	1810	1810	-
	OVERALL WIDTH	300	400	600	800	900	1200	1200	-
	COLUMN WIDTH	1X300	1X400	2X300	2X400	3X300	3X400	4X300	-
DEPTH	490	490	490	490	490	490	490	-	
EQUIPMENT	LEGS HEIGHT 100	✓	✓	✓	✓	✓	✓	✓	-
	SHELF	-	-	-	-	-	-	-	-
	BAR WITH HOOKS	-	-	-	-	-	-	-	-
	CLOTHING HOOK	✓	✓	✓	✓	✓	✓	✓	-
	KEY LOCK	✓	✓	✓	✓	✓	✓	✓	-
PADLOCK LOCK	✓	✓	✓	✓	✓	✓	✓	-	
+	TYPES OF LOCKS	AVAILABLE TYPES OF LOCKS: PAGE 92							
	ADDITIONAL OPTIONS	AVAILABLE ADDITIONAL OPTIONS: PAGE 90							
	COLOR OPTIONS	AVAILABLE COLOR OPTIONS: PAGE 173							

Five-level lockers



STANDARD VERSION

DIMENSIONS	PRODUCT CODE	AD-15315-00	AD-15415-00	AD-15325-00	AD-15425-00	AD-15335-00	AD-15435-00	AD-15345-00	-
	HEIGHT	1510	1510	1510	1510	1510	1510	1510	-
	PRODUCT CODE	AD-18315-00	AD-18415-00	AD-18325-00	AD-18425-00	AD-18335-00	AD-18435-00	AD-18345-00	-
	HEIGHT	1810	1810	1810	1810	1810	1810	1810	-
	OVERALL WIDTH	300	400	600	800	900	1200	1200	-
	COLUMN WIDTH	1X300	1X400	2X300	2X400	3X300	3X400	4X300	-
DEPTH	490	490	490	490	490	490	490	-	
EQUIPMENT	LEGS HEIGHT 100	✓	✓	✓	✓	✓	✓	✓	-
	SHELF	-	-	-	-	-	-	-	-
	BAR WITH HOOKS	-	-	-	-	-	-	-	-
	CLOTHING HOOK	-	-	-	-	-	-	-	-
	KEY LOCK	✓	✓	✓	✓	✓	✓	✓	-
PADLOCK LOCK	✓	✓	✓	✓	✓	✓	✓	-	
+	TYPES OF LOCKS	AVAILABLE TYPES OF LOCKS: PAGE 92							
	ADDITIONAL OPTIONS	AVAILABLE ADDITIONAL OPTIONS: PAGE 90							
	COLOR OPTIONS	AVAILABLE COLOR OPTIONS: PAGE 173							

Four-level lockers



STANDARD VERSION

DIMENSIONS	PRODUCT CODE	AD-15314-00	AD-15414-00	AD-15324-00	AD-15424-00	AD-15334-00	AD-15434-00	AD-15344-00	-
	HEIGHT	1510	1510	1510	1510	1510	1510	1510	-
	PRODUCT CODE	AD-18314-00	AD-18414-00	AD-18324-00	AD-18424-00	AD-18334-00	AD-18434-00	AD-18344-00	-
	HEIGHT	1810	1810	1810	1810	1810	1810	1810	-
	OVERALL WIDTH	300	400	600	800	900	1200	1200	-
	COLUMN WIDTH	1X300	1X400	2X300	2X400	3X300	3X400	4X300	-
DEPTH	490	490	490	490	490	490	490	-	
EQUIPMENT	LEGS HEIGHT 100	✓	✓	✓	✓	✓	✓	✓	-
	SHELF	-	-	-	-	-	-	-	-
	BAR WITH HOOKS	-	-	-	-	-	-	-	-
	CLOTHING HOOK	-	-	-	-	-	-	-	-
	KEY LOCK	✓	✓	✓	✓	✓	✓	✓	-
	PADLOCK LOCK	✓	✓	✓	✓	✓	✓	✓	-

+ TYPES OF LOCKS AVAILABLE TYPES OF LOCKS: PAGE 92
 ADDITIONAL OPTIONS AVAILABLE ADDITIONAL OPTIONS: PAGE 90
 COLOR OPTIONS AVAILABLE COLOR OPTIONS: PAGE 173

Clothing lockers L



STANDARD VERSION

DIMENSIONS	PRODUCT CODE	AZ-15312-00	AZ-15412-00	AZ-15322-00	AZ-15422-00	AZ-15332-00	AZ-15432-00	AZ-15342-00	-
	HEIGHT	1510	1510	1510	1510	1510	1510	1510	-
	PRODUCT CODE	AZ-18312-00	AZ-18412-00	AZ-18322-00	AZ-18422-00	AZ-18332-00	AZ-18432-00	AZ-18342-00	-
	HEIGHT	1810	1810	1810	1810	1810	1810	1810	-
	OVERALL WIDTH	300	400	600	800	900	1200	1200	-
	COLUMN WIDTH	1X300	1X400	2X300	2X400	3X300	3X400	4X300	-
DEPTH	490	490	490	490	490	490	490	-	
EQUIPMENT	LEGS HEIGHT 100	✓	✓	✓	✓	✓	✓	✓	-
	SHELF	-	-	-	-	-	-	-	-
	BAR WITH HOOKS	✓	✓	✓	✓	✓	✓	✓	-
	CLOTHING HOOK	✓	✓	✓	✓	✓	✓	✓	-
	KEY LOCK	✓	✓	✓	✓	✓	✓	✓	-
	PADLOCK LOCK	✓	✓	✓	✓	✓	✓	✓	-

+ TYPES OF LOCKS AVAILABLE TYPES OF LOCKS: PAGE 92
 ADDITIONAL OPTIONS AVAILABLE ADDITIONAL OPTIONS: PAGE 90
 COLOR OPTIONS AVAILABLE COLOR OPTIONS: PAGE 173

ARTUS lockers with piano doors



Lockers divided into three compartments

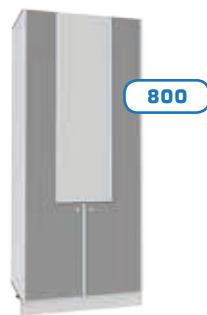

800

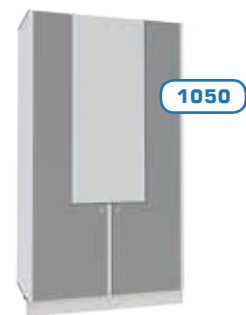

1050

STANDARD VERSION

DIMENSIONS	PRODUCT CODE	ADZ-1580	ADZ-15105
	HEIGHT	1510	1510
	PRODUCT CODE	ADZ-1880	ADZ-18105
	HEIGHT	1810	1810
	OVERALL WIDTH	800	1050
	COLUMN WIDTH	WIDTH OF COMPARTMENTS WITHOUT PROFILES - 2X190+1X300	WIDTH OF COMPARTMENTS WITHOUT PROFILES- 2X265+1X400
	DEPTH	490	490
EQUIPMENT	LEGS HEIGHT 100	✓	✓
	SHELF	✓	✓
	BAR WITH HOOKS	✓	✓
	CLOTHING HOOK	✓	✓
	KEY LOCK	✓	✓
	PADLOCK LOCK	✓	✓

+	TYPES OF LOCKS	AVAILABLE TYPES OF LOCKS: PAGE 92
	ADDITIONAL OPTIONS	AVAILABLE ADDITIONAL OPTIONS: PAGE 90
	COLOR OPTIONS	AVAILABLE COLOR OPTIONS: PAGE 173



patented hinge
manufactured by ALSANIT

stable, aluminum rod
and durable hooks
manufactured by ALSANIT

as a standard - key lock
or a padlock

body and back: HPL 4 mm

doors: HPL 10/12 mm

polyamide leg

available additional options

[page 90 →](#)

available lock options

[page 92 →](#)

available colors

[page 173 →](#)





85-104 >

HE >

HPL lockers - naturally waterproof.

The waterproofness and durability of HPL panels have become legendary. ALSANIT's HPL lockers are a combination of the material's best properties with years of experience in furniture production. It's a combination that guarantees satisfaction.

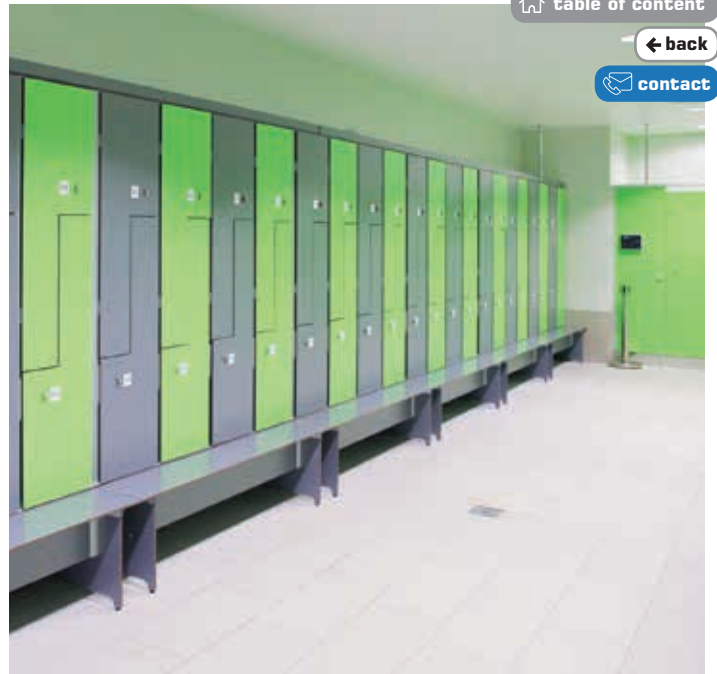

Innovative construction of aluminum profiles.

The specially developed and patented profile system allows for achieving an excellent visual impression. The profiles provide the possibility of installing LED lighting, which distinguishes ALSANIT lockers from other products.



141

143

145

147

149

151

153

155

157

142

144

146

148

150

152

154

156

158



PIANO doors with „Finger-safe” function.

The profile system allows for the installation of another innovation, which serves both safety and aesthetic functions.



LUXA lockers represent elegance in a simple form and a nod towards Scandinavian style.

Thanks to a rich color palette, they allow for many possibilities in interior design.

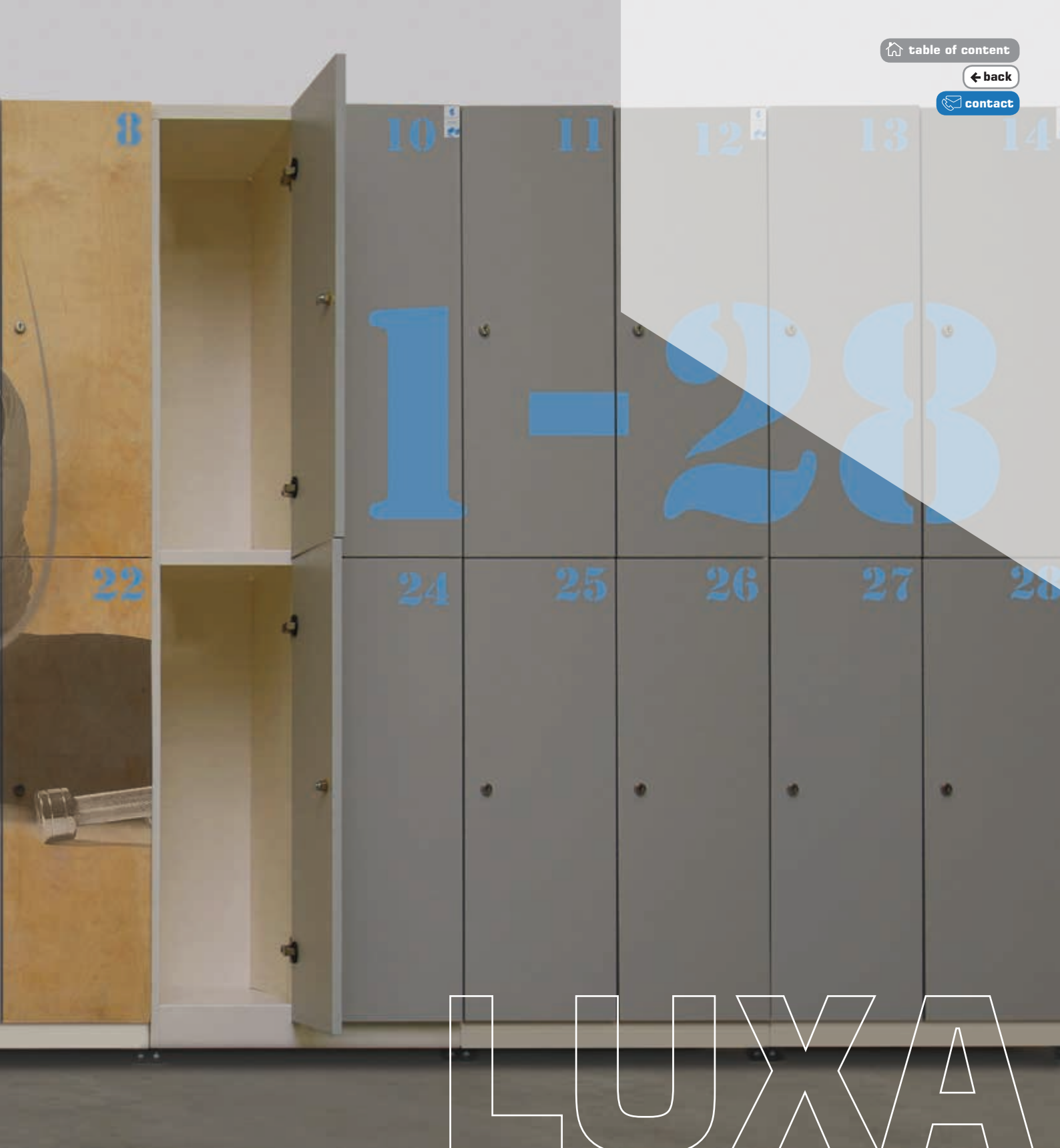

LUXA

LUXA MFC lockers

Body:

MFC - Laminated chipboard

Doors:

MFC - Laminated chipboard

 Prepared for
Smart Locker

page 96 →



Protected design:
WP.30407 (hinge)

Description:







Lockers made of chipboard are highly regarded and versatile in their application - from modern offices to fitness clubs.

In the LUXA series, the available color palette of chipboard panels is impressive, and moreover, they are available in natural textures and patterns such as stone or wood. We do not limit ourselves only to doors; the bodies can also be made according to individual preferences, based on a wide range of panel decors.

An additional accent is provided by the

edges bonded with ABS tape using the latest hot-air edge banding technology, giving the effect of an almost invisible joint. This innovative technology is a standard for us, although it appeared on the market only a few years ago.

For facilities where furniture is not exposed to excessive moisture, LUXA lockers are an excellent choice because they offer the possibility of creating original and stylish compositions at an attractive price.

-  only Torx screws are used
-  fully assembled product
-  the possibility of custom built
-  smooth inner walls
-  custom sizing available
-  easy to clean



Quality confirmed by certificates



Budget solutions



Even gaps between the doors



Frontlaying doors

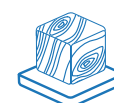

Decors also available in 3D structure



Available in High Gloss

Standard dimensions

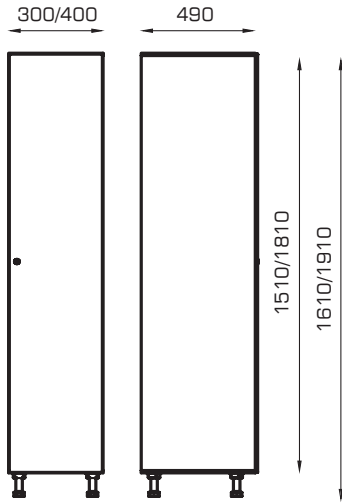

Base options

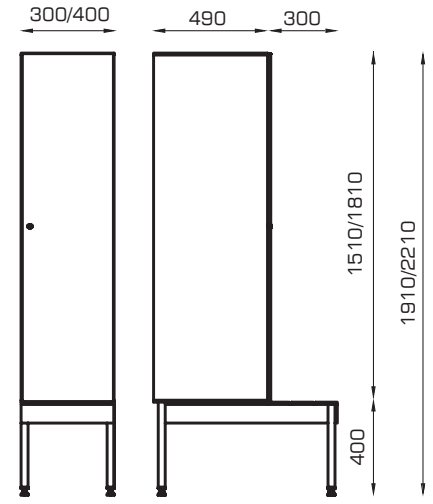
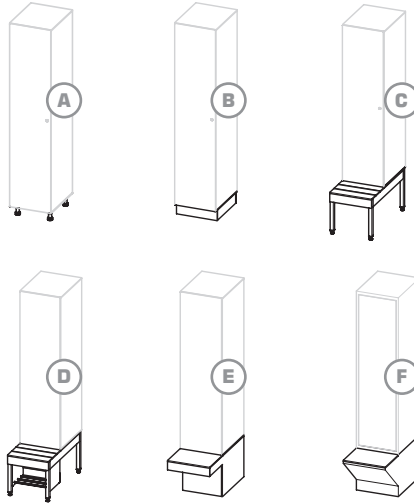

Standard equipment

patented hinge
manufactured by ALSANIT



stable, aluminum rod
and durable hooks
manufactured by ALSANIT



as a standard - key lock
or a padlock



doors, body, back: MFC 18 mm

polyamide leg



available additional
options

[page 90](#) →

available lock
options

[page 92](#) →

available
colors

[page 173](#) →



LUXA MFC lockers



Single-level lockers



STANDARD VERSION

DIMENSIONS	PRODUCT CODE	LD-15311-01	LD-15411-01	LD-15321-01	LD-15421-01	LD-15331-01	LD-15431-01	LD-15341-01	-
	HEIGHT	1510	1510	1510	1510	1510	1510	1510	-
	PRODUCT CODE	LD-18311-01	LD-18411-01	LD-18321-01	LD-18421-01	LD-18331-01	LD-18431-01	LD-18341-01	-
	HEIGHT	1810	1810	1810	1810	1810	1810	1810	-
	OVERALL WIDTH	300	400	600	800	900	1200	1200	-
	COLUMN WIDTH	1X300	1X400	2X300	2X400	3X300	3X400	4X300	-
	DEPTH	490	490	490	490	490	490	490	-
EQUIPMENT	LEGS HEIGHT 100	✓	✓	✓	✓	✓	✓	✓	-
	SHELF	✓	✓	✓	✓	✓	✓	✓	-
	BAR WITH HOOKS	✓	✓	✓	✓	✓	✓	✓	-
	CLOTHING HOOK	✓	✓	✓	✓	✓	✓	✓	-
	KEY LOCK	✓	✓	✓	✓	✓	✓	✓	-
	PADLOCK LOCK	✓	✓	✓	✓	✓	✓	✓	-
+	TYPES OF LOCKS	AVAILABLE TYPES OF LOCKS: PAGE 92							
	ADDITIONAL OPTIONS	AVAILABLE ADDITIONAL OPTIONS: PAGE 90							
	COLOR OPTIONS	AVAILABLE COLOR OPTIONS: PAGE 173							



LUXA

Two-level lockers



STANDARD VERSION

DIMENSIONS	PRODUCT CODE	LD-15312-01	LD-15412-01	LD-15322-01	LD-15422-01	LD-15332-01	LD-15432-01	LD-15342-01	-
	HEIGHT	1510	1510	1510	1510	1510	1510	1510	-
	PRODUCT CODE	LD-18312-01	LD-18412-01	LD-18322-01	LD-18422-01	LD-18332-01	LD-18432-01	LD-18342-01	-
	HEIGHT	1810	1810	1810	1810	1810	1810	1810	-
	OVERALL WIDTH	300	400	600	800	900	1200	1200	-
	COLUMN WIDTH	1X300	1X400	2X300	2X400	3X300	3X400	4X300	-
DEPTH	490	490	490	490	490	490	490	-	
EQUIPMENT	LEGS HEIGHT 100	✓	✓	✓	✓	✓	✓	✓	-
	SHELF	✓	✓	✓	✓	✓	✓	✓	-
	BAR WITH HOOKS	✓	✓	✓	✓	✓	✓	✓	-
	CLOTHING HOOK	✓	✓	✓	✓	✓	✓	✓	-
	KEY LOCK	✓	✓	✓	✓	✓	✓	✓	-
	PADLOCK LOCK	✓	✓	✓	✓	✓	✓	✓	-

+	TYPES OF LOCKS	AVAILABLE TYPES OF LOCKS: PAGE 92
	ADDITIONAL OPTIONS	AVAILABLE ADDITIONAL OPTIONS: PAGE 90
	COLOR OPTIONS	AVAILABLE COLOR OPTIONS: PAGE 173

LUXA MFC lockers

Three-level lockers

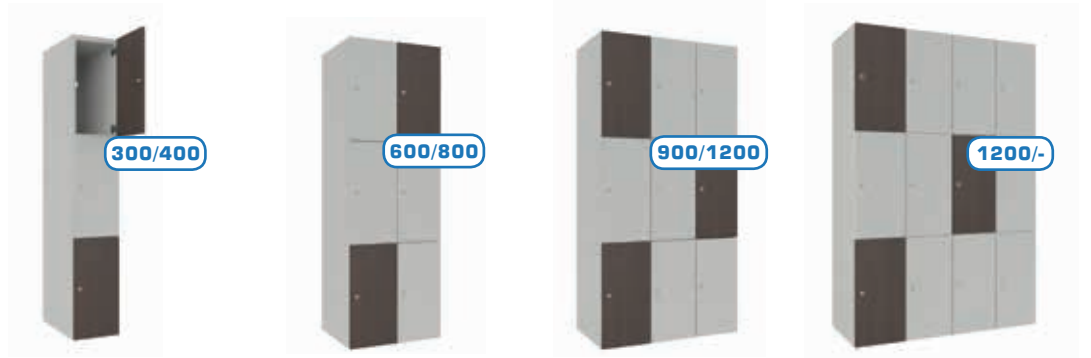

STANDARD VERSION

DIMENSIONS	PRODUCT CODE	LD-15313-00	LD-15413-00	LD-15323-00	LD-15423-00	LD-15333-00	LD-15433-00	LD-15343-00	-
	HEIGHT	1510	1510	1510	1510	1510	1510	1510	-
	PRODUCT CODE	LD-18313-00	LD-18413-00	LD-18323-00	LD-18423-00	LD-18333-00	LD-18433-00	LD-18343-00	-
	HEIGHT	1810	1810	1810	1810	1810	1810	1810	-
	OVERALL WIDTH	300	400	600	800	900	1200	1200	-
	COLUMN WIDTH	1X300	1X400	2X300	2X400	3X300	3X400	4X300	-
DEPTH	490	490	490	490	490	490	490	-	
EQUIPMENT	LEGS HEIGHT 100	✓	✓	✓	✓	✓	✓	✓	-
	SHELF	-	-	-	-	-	-	-	-
	BAR WITH HOOKS	-	-	-	-	-	-	-	-
	CLOTHING HOOK	✓	✓	✓	✓	✓	✓	✓	-
	KEY LOCK	✓	✓	✓	✓	✓	✓	✓	-
PADLOCK LOCK	✓	✓	✓	✓	✓	✓	✓	-	
+	TYPES OF LOCKS	AVAILABLE TYPES OF LOCKS: PAGE 92							
	ADDITIONAL OPTIONS	AVAILABLE ADDITIONAL OPTIONS: PAGE 90							
	COLOR OPTIONS	AVAILABLE COLOR OPTIONS: PAGE 173							

Five-level lockers



STANDARD VERSION

DIMENSIONS	PRODUCT CODE	LD-15315-00	LD-15415-00	LD-15325-00	LD-15425-00	LD-15335-00	LD-15435-00	LD-15345-00	-
	HEIGHT	1510	1510	1510	1510	1510	1510	1510	-
	PRODUCT CODE	LD-18315-00	LD-18415-00	LD-18325-00	LD-18425-00	LD-18335-00	LD-18435-00	LD-18345-00	-
	HEIGHT	1810	1810	1810	1810	1810	1810	1810	-
	OVERALL WIDTH	300	400	600	800	900	1200	1200	-
	COLUMN WIDTH	1X300	1X400	2X300	2X400	3X300	3X400	4X300	-
DEPTH	490	490	490	490	490	490	490	-	
EQUIPMENT	LEGS HEIGHT 100	✓	✓	✓	✓	✓	✓	✓	-
	SHELF	-	-	-	-	-	-	-	-
	BAR WITH HOOKS	-	-	-	-	-	-	-	-
	CLOTHING HOOK	-	-	-	-	-	-	-	-
	KEY LOCK	✓	✓	✓	✓	✓	✓	✓	-
PADLOCK LOCK	✓	✓	✓	✓	✓	✓	✓	-	
+	TYPES OF LOCKS	AVAILABLE TYPES OF LOCKS: PAGE 92							
	ADDITIONAL OPTIONS	AVAILABLE ADDITIONAL OPTIONS: PAGE 90							
	COLOR OPTIONS	AVAILABLE COLOR OPTIONS: PAGE 173							

Four-level lockers



STANDARD VERSION

DIMENSIONS	PRODUCT CODE	LD-15314-00	LD-15414-00	LD-15324-00	LD-15424-00	LD-15334-00	LD-15434-00	LD-15344-00	-
	HEIGHT	1510	1510	1510	1510	1510	1510	1510	1510
EQUIPMENT	PRODUCT CODE	LD-18314-00	LD-18414-00	LD-18324-00	LD-18424-00	LD-18334-00	LD-18434-00	LD-18344-00	-
	HEIGHT	1810	1810	1810	1810	1810	1810	1810	-
	OVERALL WIDTH	300	400	600	800	900	1200	1200	-
	COLUMN WIDTH	1X300	1X400	2X300	2X400	3X300	3X400	4X300	-
	DEPTH	490	490	490	490	490	490	490	-
LEGS HEIGHT 100	✓	✓	✓	✓	✓	✓	✓	-	
SHELF	-	-	-	-	-	-	-	-	
BAR WITH HOOKS	-	-	-	-	-	-	-	-	
CLOTHING HOOK	-	-	-	-	-	-	-	-	
KEY LOCK	✓	✓	✓	✓	✓	✓	✓	-	
PADLOCK LOCK	✓	✓	✓	✓	✓	✓	✓	-	

+	TYPES OF LOCKS	AVAILABLE TYPES OF LOCKS: PAGE 92
	ADDITIONAL OPTIONS	AVAILABLE ADDITIONAL OPTIONS: PAGE 90
	COLOR OPTIONS	AVAILABLE COLOR OPTIONS: PAGE 173





1

5

9

3

7

11

2

6

10

4

8

12



Big impression at a small price.

By using cost-effective materials and a rich color palette, you can achieve a WOW effect without risking budget strain.



Design support - together we create space.

Thanks to cooperation with ALSANIT,
it's easy to brighten up and add variety
to interiors.

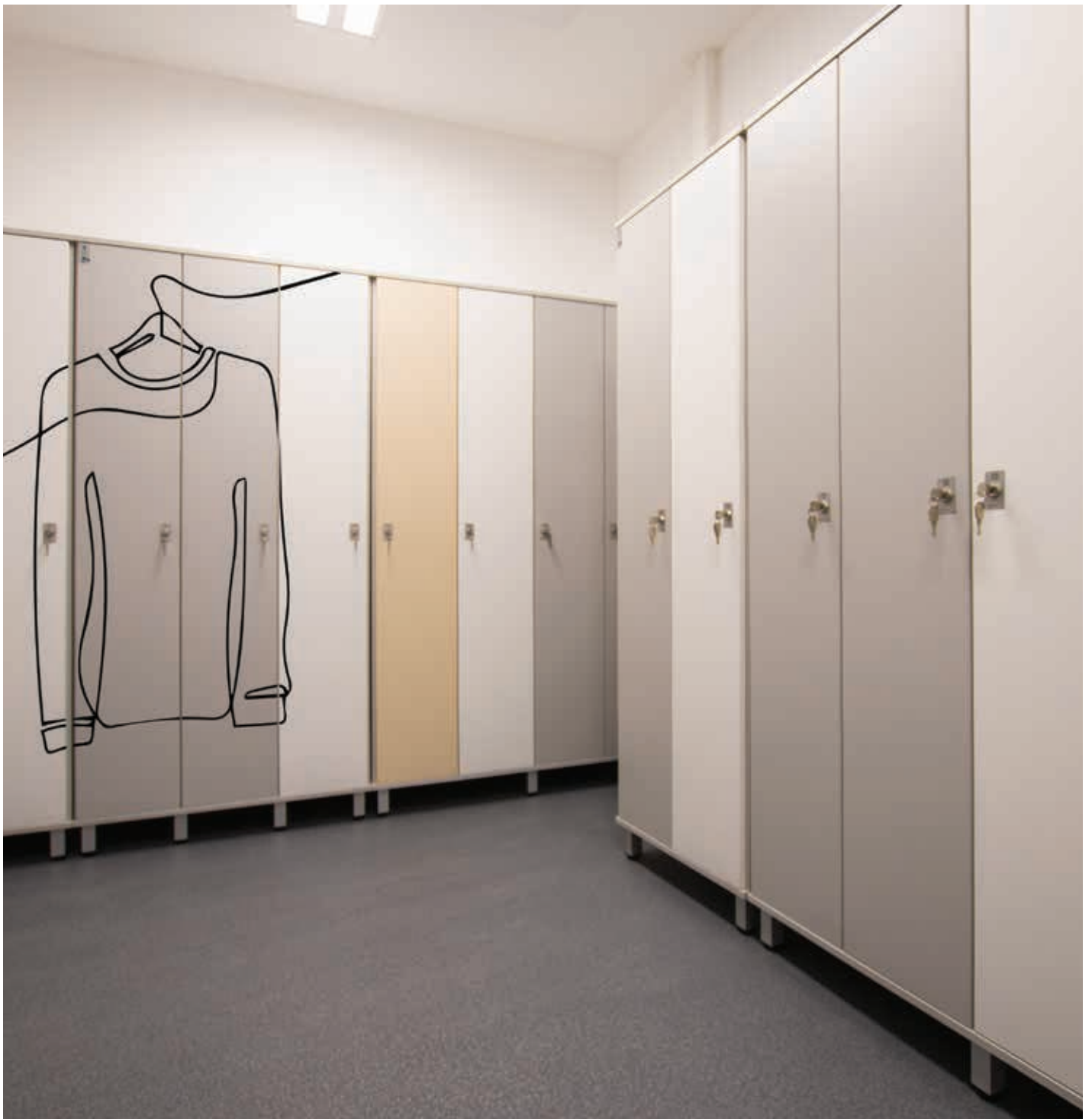



Metal furniture is one of our specialties - we design and manufacture it ourselves.

We pay attention to every detail to meet the users' requirements and provide the best solution for a budget-friendly metal locker.

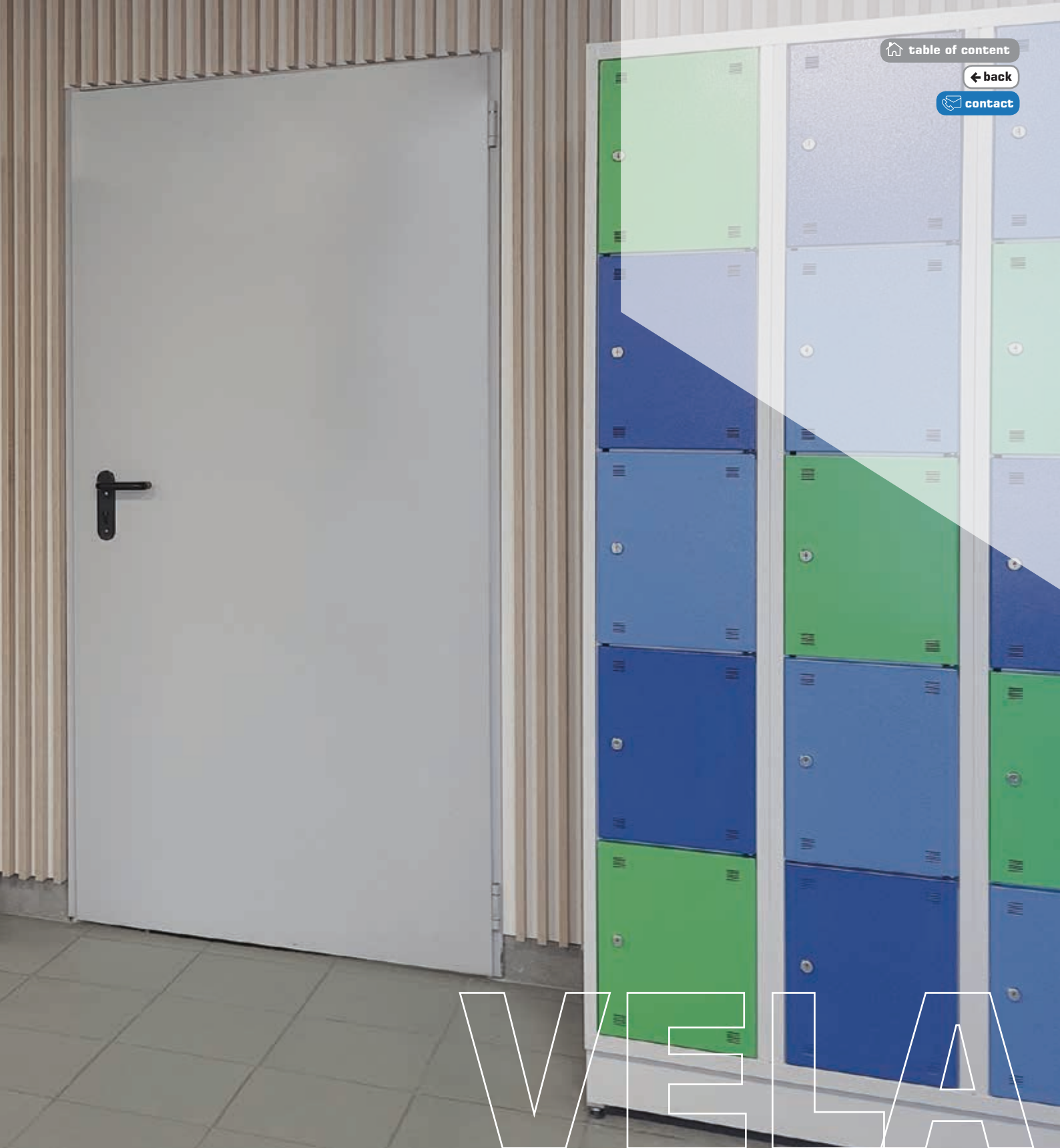

[table of content](#)

[back](#)

[contact](#)

VELA

VELA

VELA metal body, metal / hpl / mfc doors

Body:

METAL - Powder-coated galvanized steel

Doors:

METAL - Powder-coated galvanized steel

HPL - High pressure laminate

MFC - Laminated chipboard

Description:

In the competitive market of metal lockers, many companies promote their products primarily based on price. However, the lowest price does not necessarily align with quality.

VELA lockers are available at a competitive price, but our priority in their design was to ensure quality and durability better than that of other manufacturers. We aimed to guarantee long-lasting, trouble-free use, which in the long run is more cost-effective than purchasing the cheapest products that quickly de-

teriorate.

The bodies are always made of galvanized steel, with adjustable legs and durable accessories like those from our higher-end locker models. The ventilation system helps to avoid unpleasant odors and moisture buildup inside the locker, which is particularly important in schools and changing rooms where shoes and clothing are stored.

VELA lockers meet all legal requirements and are recommended with full confidence.

 Prepared for
Smart Locker

page 96 →

 fully assembled product

 employee lockers - standard vertical partition

 reinforced metal doors

 easy to clean



Quality confirmed by certificates



Budget solutions



Even gaps between the doors



Certificate of conformity



Central access

page 80 →

Standard dimensions

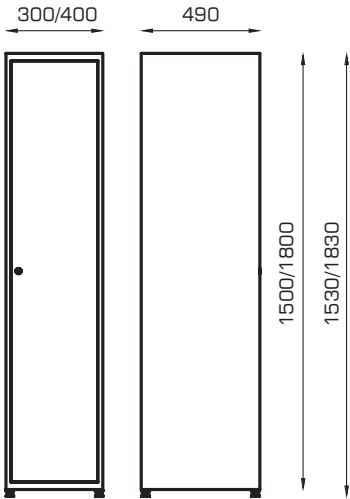

Base options

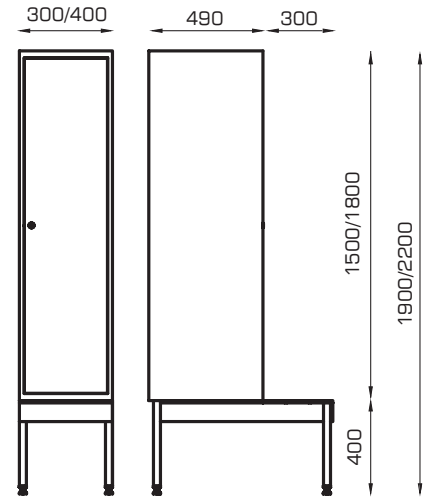
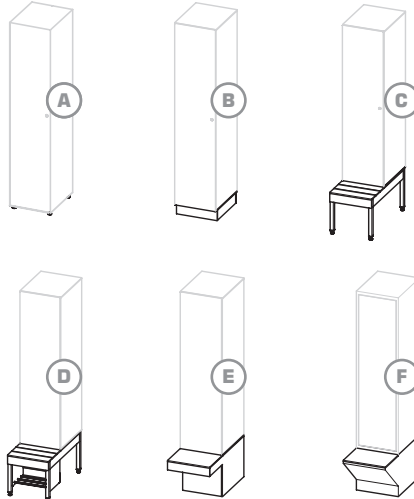

Standard equipment



available additional options

[page 90](#) →

available lock options

[page 92](#) →

available colors

[page 173](#) →



VELA metal body, metal / hpl / mfc doors



Single-level lockers

Doors available in:

METAL MFC HPL

STANDARD VERSION



DIMENSIONS	PRODUCT CODE	VD-15311-11	VD-15411-11	VD-15321-11	VD-15421-11	VD-15331-11	VD-15431-11	VD-15341-11	-
	HEIGHT	1500	1500	1500	1500	1500	1500	1500	-
	PRODUCT CODE	VD-18311-11	VD-18411-11	VD-18321-11	VD-18421-11	VD-18331-11	VD-18431-11	VD-18341-11	-
	HEIGHT	1800	1800	1800	1800	1800	1800	1800	-
	OVERALL WIDTH	300	400	600	800	900	1200	1200	-
	COLUMN WIDTH	1X300	1X400	2X300	2X400	3X300	3X400	4X300	-
	DEPTH	490	490	490	490	490	490	490	-
EQUIPMENT	LEGS HEIGHT 30	✓	✓	✓	✓	✓	✓	✓	-
	SHELF + PRZEGRODA	✓	✓	✓	✓	✓	✓	✓	-
	BAR WITH HOOKS	✓	✓	✓	✓	✓	✓	✓	-
	CLOTHING HOOK	✓	✓	✓	✓	✓	✓	✓	-
	KEY LOCK	✓	✓	✓	✓	✓	✓	✓	-
	PADLOCK LOCK	✓	✓	✓	✓	✓	✓	✓	-

+	TYPES OF LOCKS	AVAILABLE TYPES OF LOCKS: PAGE 92
	ADDITIONAL OPTIONS	AVAILABLE ADDITIONAL OPTIONS: PAGE 90
	COLOR OPTIONS	AVAILABLE COLOR OPTIONS: PAGE 173



Two-level lockers

Doors available in:

- [METAL](#)
[MFC](#)
[HPL](#)

STANDARD VERSION



DIMENSIONS	PRODUCT CODE	VD-15312-01	VD-15412-01	VD-15322-01	VD-15422-01	VD-15332-01	VD-15432-01	VD-15342-01	-
	HEIGHT	1500	1500	1500	1500	1500	1500	1500	-
	PRODUCT CODE	VD-18312-01	VD-18412-01	VD-18322-01	VD-18422-01	VD-18332-01	VD-18432-01	VD-18342-01	-
	HEIGHT	1800	1800	1800	1800	1800	1800	1800	-
	OVERALL WIDTH	300	400	600	800	900	1200	1200	-
	COLUMN WIDTH	1X300	1X400	2X300	2X400	3X300	3X400	4X300	-
	DEPTH	490	490	490	490	490	490	490	-
EQUIPMENT	LEGS HEIGHT 30	✓	✓	✓	✓	✓	✓	✓	-
	SHELF	✓	✓	✓	✓	✓	✓	✓	-
	BAR WITH HOOKS	✓	✓	✓	✓	✓	✓	✓	-
	CLOTHING HOOK	✓	✓	✓	✓	✓	✓	✓	-
	KEY LOCK	✓	✓	✓	✓	✓	✓	✓	-
	PADLOCK LOCK	✓	✓	✓	✓	✓	✓	✓	-

+	TYPES OF LOCKS	AVAILABLE TYPES OF LOCKS: PAGE 92
	ADDITIONAL OPTIONS	AVAILABLE ADDITIONAL OPTIONS: PAGE 90
	COLOR OPTIONS	AVAILABLE COLOR OPTIONS: PAGE 173

VELA metal body, metal / hpl / mfc doors

Three-level lockers

Doors available in:

METAL MFC HPL

STANDARD VERSION



DIMENSIONS	PRODUCT CODE	VD-15313-00	VD-15413-00	VD-15323-00	VD-15423-00	VD-15333-00	VD-15433-00	VD-15343-00	-
	HEIGHT	1500	1500	1500	1500	1500	1500	1500	-
	PRODUCT CODE	VD-18313-00	VD-18413-00	VD-18323-00	VD-18423-00	VD-18333-00	VD-18433-00	VD-18343-00	-
	HEIGHT	1800	1800	1800	1800	1800	1800	1800	-
	OVERALL WIDTH	300	400	600	800	900	1200	1200	-
	COLUMN WIDTH	1X300	1X400	2X300	2X400	3X300	3X400	4X300	-
DEPTH	490	490	490	490	490	490	490	-	
EQUIPMENT	LEGS HEIGHT 30	✓	✓	✓	✓	✓	✓	✓	-
	SHELF	-	-	-	-	-	-	-	-
	BAR WITH HOOKS	-	-	-	-	-	-	-	-
	CLOTHING HOOK	✓	✓	✓	✓	✓	✓	✓	-
	KEY LOCK	✓	✓	✓	✓	✓	✓	✓	-
PADLOCK LOCK	✓	✓	✓	✓	✓	✓	✓	-	
+	TYPES OF LOCKS	AVAILABLE TYPES OF LOCKS: PAGE 92							
	ADDITIONAL OPTIONS	AVAILABLE ADDITIONAL OPTIONS: PAGE 90							
	COLOR OPTIONS	AVAILABLE COLOR OPTIONS: PAGE 173							

Five-level lockers

Doors available in:

METAL MFC HPL

STANDARD VERSION



DIMENSIONS	PRODUCT CODE	VD-15315-00	VD-15415-00	VD-15325-00	VD-15425-00	VD-15335-00	VD-15435-00	VD-15345-00	-
	HEIGHT	1500	1500	1500	1500	1500	1500	1500	-
	PRODUCT CODE	VD-18315-00	VD-18415-00	VD-18325-00	VD-18425-00	VD-18335-00	VD-18435-00	VD-18345-00	-
	HEIGHT	1800	1800	1800	1800	1800	1800	1800	-
	OVERALL WIDTH	300	400	600	800	900	1200	1200	-
	COLUMN WIDTH	1X300	1X400	2X300	2X400	3X300	3X400	4X300	-
DEPTH	490	490	490	490	490	490	490	-	
EQUIPMENT	LEGS HEIGHT 30	✓	✓	✓	✓	✓	✓	✓	-
	SHELF	-	-	-	-	-	-	-	-
	BAR WITH HOOKS	-	-	-	-	-	-	-	-
	CLOTHING HOOK	-	-	-	-	-	-	-	-
	KEY LOCK	✓	✓	✓	✓	✓	✓	✓	-
PADLOCK LOCK	✓	✓	✓	✓	✓	✓	✓	-	
+	TYPES OF LOCKS	AVAILABLE TYPES OF LOCKS: PAGE 92							
	ADDITIONAL OPTIONS	AVAILABLE ADDITIONAL OPTIONS: PAGE 90							
	COLOR OPTIONS	AVAILABLE COLOR OPTIONS: PAGE 173							

Four-level lockers

Doors available in:

METAL MFC HPL



STANDARD VERSION

DIMENSIONS	PRODUCT CODE	VD-15314-00	VD-15414-00	VD-15324-00	VD-15424-00	VD-15334-00	VD-15434-00	VD-15344-00	-
	HEIGHT	1500	1500	1500	1500	1500	1500	1500	-
	PRODUCT CODE	VD-18314-00	VD-18414-00	VD-18324-00	VD-18424-00	VD-18334-00	VD-18434-00	VD-18344-00	-
	HEIGHT	1800	1800	1800	1800	1800	1800	1800	-
	OVERALL WIDTH	300	400	600	800	900	1200	1200	-
	COLUMN WIDTH	1X300	1X400	2X300	2X400	3X300	3X400	4X300	-
DEPTH	490	490	490	490	490	490	490	-	
EQUIPMENT	LEGS HEIGHT 30	✓	✓	✓	✓	✓	✓	✓	-
	SHELF	-	-	-	-	-	-	-	-
	BAR WITH HOOKS	-	-	-	-	-	-	-	-
	CLOTHING HOOK	-	-	-	-	-	-	-	-
	KEY LOCK	✓	✓	✓	✓	✓	✓	✓	-
	PADLOCK LOCK	✓	✓	✓	✓	✓	✓	✓	-

+ TYPES OF LOCKS AVAILABLE TYPES OF LOCKS: PAGE 92
 ADDITIONAL OPTIONS AVAILABLE ADDITIONAL OPTIONS: PAGE 90
 COLOR OPTIONS AVAILABLE COLOR OPTIONS: PAGE 173

Clothing lockers L

Doors available in:

METAL HPL

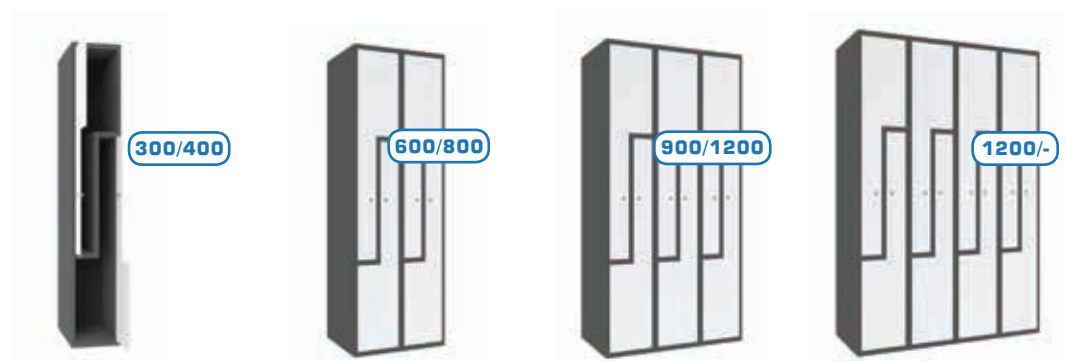

STANDARD VERSION

DIMENSIONS	PRODUCT CODE	VZ-15312-00	VZ-15412-00	VZ-15322-00	VZ-15422-00	VZ-15332-00	VZ-15432-00	VZ-15342-00	-
	HEIGHT	1500	1500	1500	1500	1500	1500	1500	-
	PRODUCT CODE	VZ-18312-00	VZ-18412-00	VZ-18322-00	VZ-18422-00	VZ-18332-00	VZ-18432-00	VZ-18342-00	-
	HEIGHT	1800	1800	1800	1800	1800	1800	1800	-
	OVERALL WIDTH	300	400	600	800	900	1200	1200	-
	COLUMN WIDTH	1X300	1X400	2X300	2X400	3X300	3X400	4X300	-
DEPTH	490	490	490	490	490	490	490	-	
EQUIPMENT	LEGS HEIGHT 30	✓	✓	✓	✓	✓	✓	✓	-
	SHELF	-	-	-	-	-	-	-	-
	BAR WITH HOOKS	✓	✓	✓	✓	✓	✓	✓	-
	CLOTHING HOOK	✓	✓	✓	✓	✓	✓	✓	-
	KEY LOCK	✓	✓	✓	✓	✓	✓	✓	-
	PADLOCK LOCK	✓	✓	✓	✓	✓	✓	✓	-

+ TYPES OF LOCKS AVAILABLE TYPES OF LOCKS: PAGE 92
 ADDITIONAL OPTIONS AVAILABLE ADDITIONAL OPTIONS: PAGE 90
 COLOR OPTIONS AVAILABLE COLOR OPTIONS: PAGE 173

VELA C lockers with central access

Lockers with central access



600



1200

WERSJA STANDARD

DIMENSIONS	PRODUCT CODE	VDC-15321-11	VDC-15341-11
	HEIGHT	1510	1510
	PRODUCT CODE	VDC-18321-11	VDC-18341-11
	HEIGHT	1810	1810
	OVERALL WIDTH	600	1200
	COLUMN WIDTH	300	300
DEPTH	490	490	
EQUIPMENT	LEGS HEIGHT 100	✓	✓
	SHELF	✓	✓
	BAR WITH HOOKS	✓	✓
	CLOTHING HOOK	✓	✓
	KEY LOCK	✓	✓
	PADLOCK LOCK	✓	✓
+	TYPES OF LOCKS	AVAILABLE TYPES OF LOCKS: PAGE 92	
	ADDITIONAL OPTIONS	AVAILABLE ADDITIONAL OPTIONS: PAGE 90	
	COLOR OPTIONS	AVAILABLE COLOR OPTIONS: PAGE 173	

hinge manufactured by ALSANIT

stable, aluminum rod and durable hooks manufactured by ALSANIT

as a standard - key lock or a padlock

doors available in: METAL 0,7 mm, HPL 10 mm, MFC 18 mm

body and back made of galvanized steel: 0.7 mm powder-coated

adjustable leg

available additional options

page 90 →

available lock options

page 92 →

available colors

page 173 →

VELA many possibilities

Smooth doors

Standard execution.



Ideal for employee lockers.
Additional partition as standard.

At no extra charge, we install the partition separating the area for clean clothes and dirty clothes. A must-have in employee lockers.



Metal doors with perforation

Possible to be done at no extra charge.



Excellent for schools.
Doors reinforced with OMEGA profile.

The additional reinforcement of metal doors ensures that even budget lockers are durable and resilient at schools.



Doors with a plexiglass window

Available for a surcharge.



Why choose VELA lockers?

Vela offers a wide range of configuration options at an affordable price.

It is a system that utilizes metal bodies optimally tailored to the needs of users in places such as schools, workplaces, and offices. There is the possibility of using various door options - from choosing the material, METAL, HPL, or MFC, to their function, and matching the color.



Galvanized steel - an ALSANIT standard that makes a difference.

By using galvanized steel, we ensure that our products are an investment for many years to come. We constantly strive to deliver products that are better than those currently available on the market.

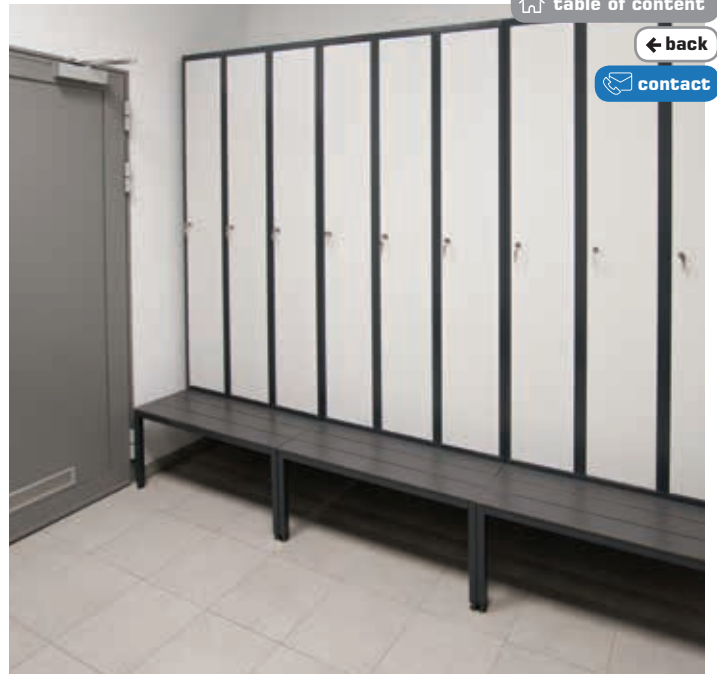



Prepared for SMART LOCKERS.

With years of experience in delivering intelligent locker systems, our products are prepared for SMART LOCKERS installation.

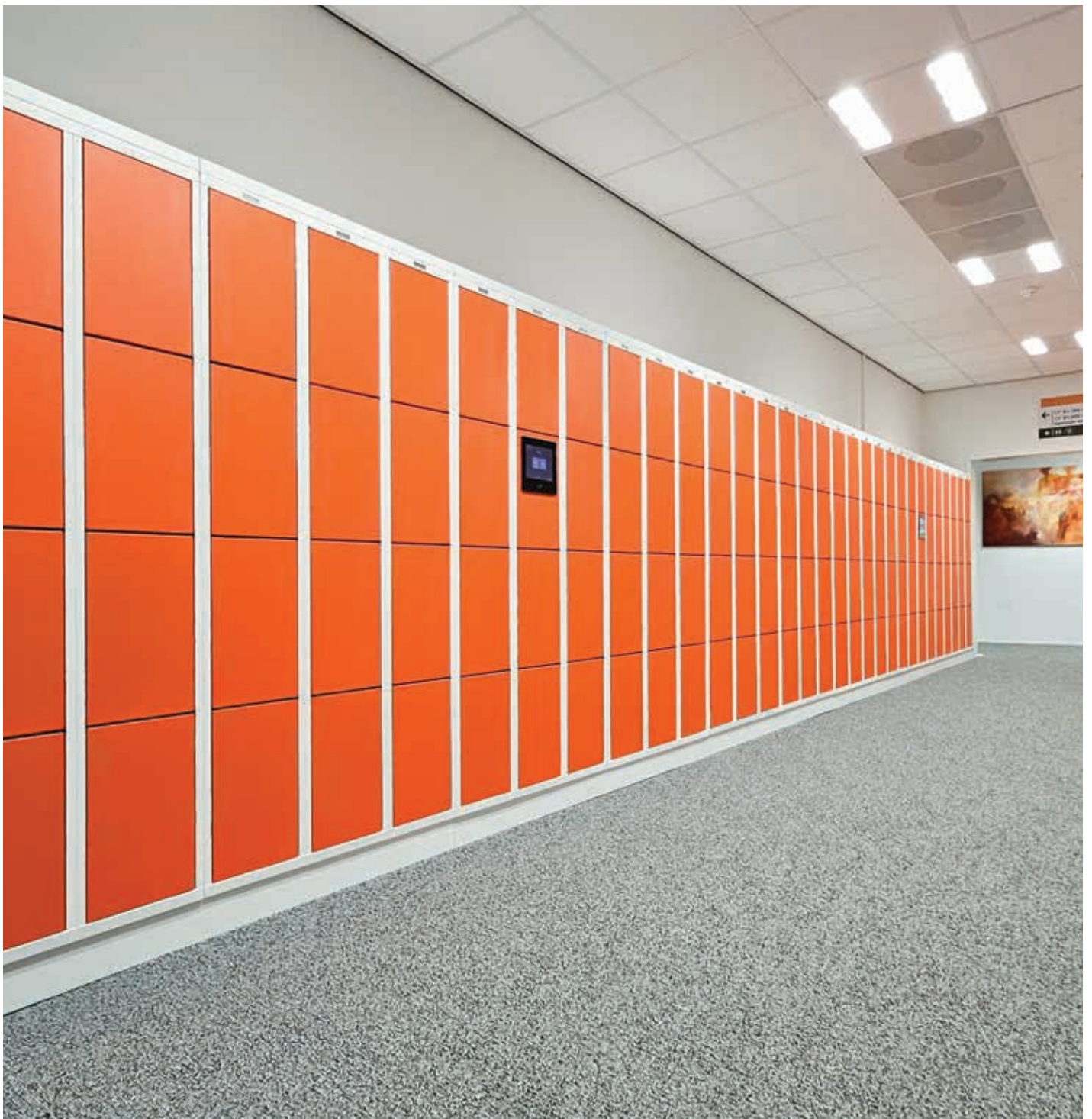



BENCHES

Benches are the perfect add on to any locker room.

Properly chosen, they can add character to the interior - make it more friendly and inviting.

available
colors



page 173 →

Benches PRO-FI

HPL

10 mm

12 mm

Classic approach

Aluminum construction with seats made of HPL.
Standard ALSANIT benches.

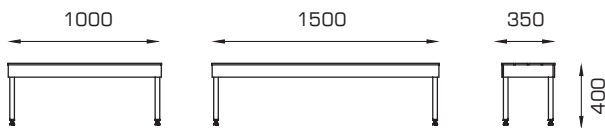
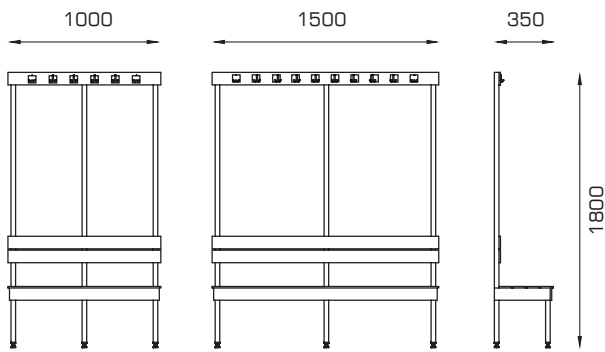

Benches LO-FI

HPL

10 mm

12 mm

Metal bench with an eye-catching seat

An elegant combination of steel and wood-like HPL panels.
Optionally include hooks.

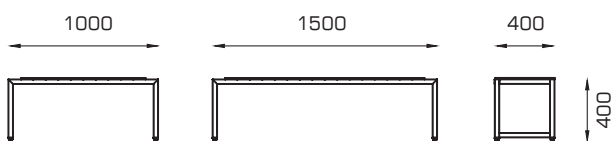
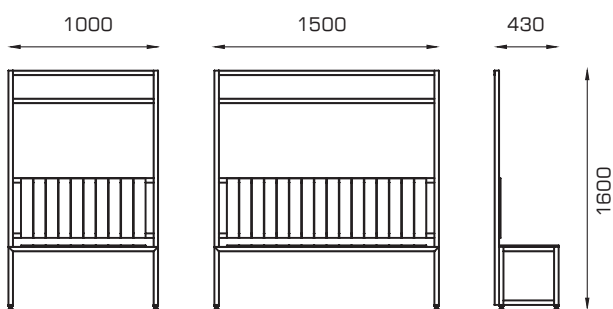

Benches HI-FI

HPL

10 mm

12 mm

Openwork backs

Steel frames with HPL seats.

Optionally include hooks.

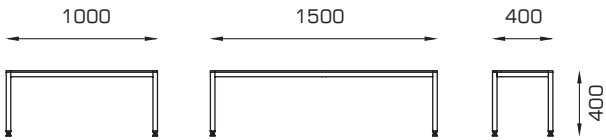
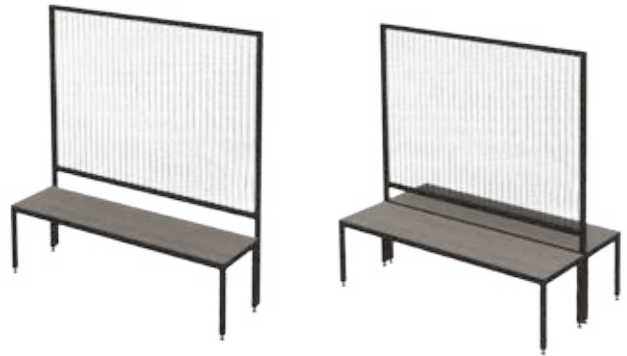
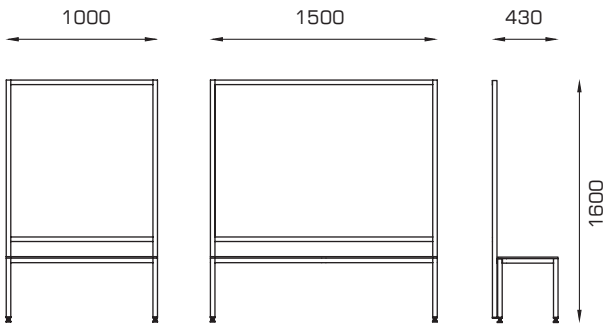

Options - available for any model

Option with low backrest

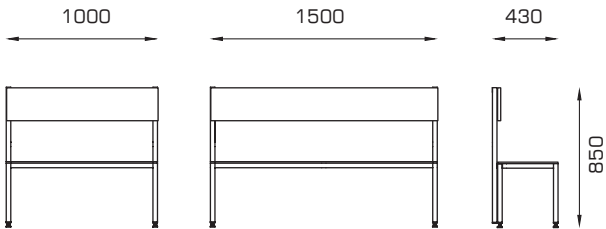

Optional slat direction for seats

Optional shoe shelf



Upholstered benches

Elegance and comfort

The combination of a classic bench with elegant upholstery - beauty and elegance encapsulated in a simple minimalist form. Perfect for both modern and classical interiors.

IRIS

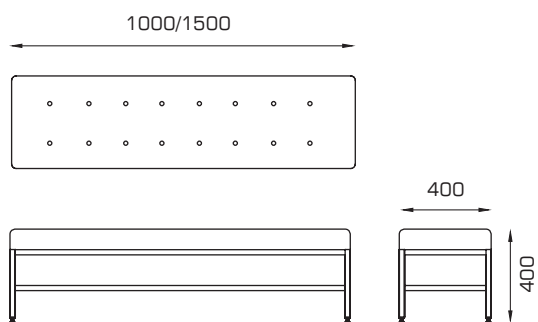

LANDO

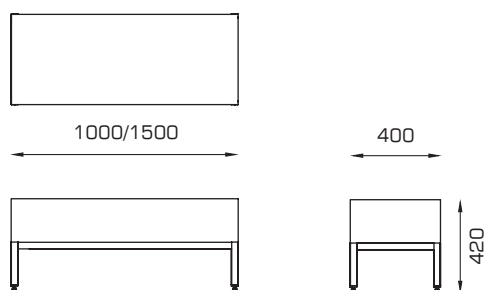

Additional options



AVAILABLE FOR LOCKERS MADE OF:

	HPL	METAL	MFC
PLATE 30X30	✓	✓	✓
PLATE 35X60	✓	✓	✓
PLATE 45X120	✓	✓	✓
ENGRAVING	✓	-	-
BAR WITH HOOKS	✓	✓	✓
ANTI-BURGLARY SYSTEM	✓	-	✓

POSSIBILITY OF MAKING FROM:

	HPL	METAL	MFC
CUSTOM DIVISION	✓	✓	✓
SLANTED ROOF	✓	✓	-
PLINTH	✓	✓	✓
LEG COVERS	✓	-	✓



[table of content](#)

[back](#)

[contact](#)

Connecting lockers into wardrobes

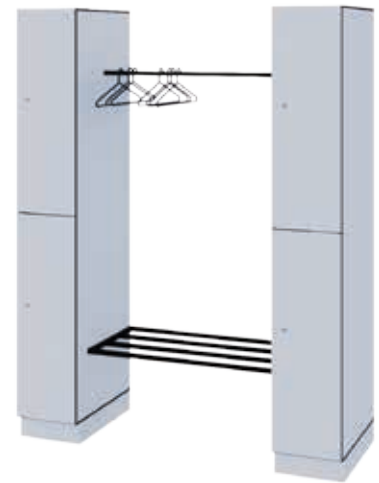
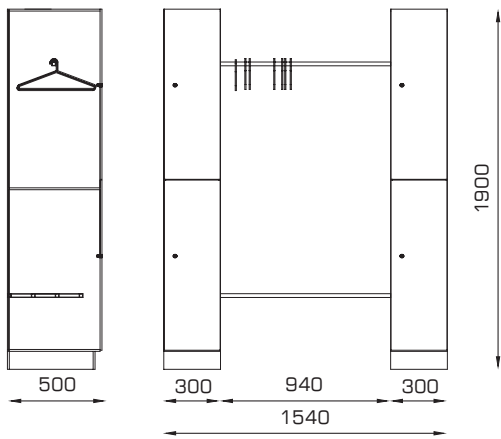

Side and corner covers

HPL / MFC / METAL

MIRROR

HPL / MFC / METAL

VANITY

[page 120](#) →

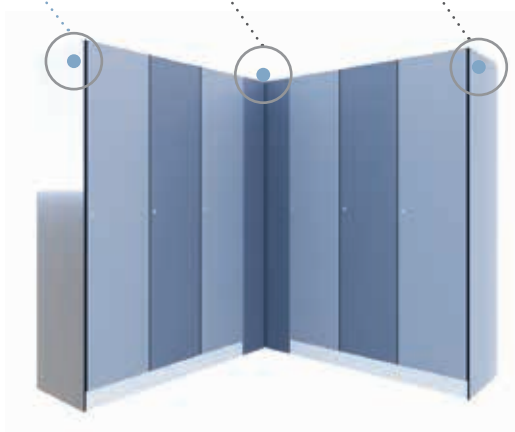

Locks for lockers

Security - a common value of the locks we offer, that is why we only provide those from reputable manufacturers. Below, we describe three additional features that guided us in selecting the locks for our products.

Waterproofnes - prepared to work in any conditions.

Prioritizing quality above all, we have decided that all locks offered by us are suitable for use in moist areas.

Interchangeability - lock models can be exchanged at any time, changing from a lower model to a higher one. This way, the locker room can be modernized without the need for costly door replacement. When changing locks to deposit or electronic locks, additional holes will have to be made in doors.

Availability - don't waste time waiting.

A strong aspect of our offer is the availability of locks on stock, significantly reducing the time needed to complete the order. For projects with slot or digital locks above 200 compartments, please contact us to confirm availability.

Cam locks, the locks we offer have a 1/1000 combination, meaning the chance of opening with your key any another locker is 0.1%.



Padlock locks, an alternative to key locks is padlocks. The recommended shackle diameter for padlocks is 5-7 mm.



The option to use any lock.

We are not limited to our own selection; we can integrate the locker with any lock specified by the client.

Code locks are maintenance-free solutions. All code locks offered by us have a master key opening option in case the code is forgotten.



Deposit locks, Coin-operated or token-operated locks are capable of accepting coins or tokens into a special container. Locks can operate on coins of 1/2 EUR. In case of key loss, locks can be opened using a master key.



Electronic lock that support the standard RFID are modern programmable locks operated by CARDS, WRISTBANDS, or other RFID TOKENS. Available in both OFFLINE versions powered by batteries and ONLINE versions powered externally.





SMART LOCKERS

Smart Locker systems provide solutions for every type of business. Discover the details and see how you can benefit from them.



SMART LOCKERS

The benefits of using Smart Lockers

What is a Smart Locker and why is it the product of the future?

A Smart Locker is more than just a storage or parcel delivery point. It consolidates various functions into one system, addressing the logistical challenges faced by modern businesses, institutions, and schools. It provides solutions for personal item storage, product sales or rentals,

parcel delivery and pickup, as well as controlled distribution of company or institutional items. These are just a few examples of the many applications of Smart Lockers.

SMART LOCKER transforms lockers into solutions

ALSANIT introduces innovative solutions in the field of lockers with smart locks, enabling electronic control over them.

Thanks to cooperation with the renowned brand SMART LOCKER, representing the most advanced intelligent locking system available on the market, we can confidently offer this solution to our customers.

SMART LOCKER stands out not only for its ease of use but also for its rich configuration options, ensuring easy management and convenient use.



The possibility of integration for any ALSANIT locker system



Full service including installation and training



The ability to integrate with the client's database



The ability to customize the software to individual needs

SMART LOCKER is an intelligent locker system that introduces a new era of facility management.



Smart Lockers

Modern companies and institutions are choosing SMART LOCKER

- Receive all your parcels from any carrier in one place.
- Effortlessly dispense workwear or distribute mail.
- Exchange documents or keys using easily managed lockers.
- Reduce costs by flexibly assigning users to lockers in the changing room.
- Control the circulation of tools or electronic equipment.
- Earn money by selling oversized items in hospitals, sports facilities, etc.

Examples of applications by industry

INDUSTRIES

	OFFICES	SCHOOLS	STORES	PHARMACY	FACTORIES	SPORTS FACILITIES	LOGISTICS SHIPMENTS	HEALTHCARE	PUBLIC AREAS	GASTRONOMY
FUNCTIONS										
STORAGE	✓	✓				✓		✓	✓	✓
DISPENSE	✓	✓	✓	✓	✓	✓	✓	✓		
DROP OFF / PICK UP	✓	✓	✓		✓		✓		✓	
VENDING	✓		✓	✓		✓		✓	✓	✓
CLOAKROOM	✓	✓	✓		✓	✓	✓	✓	✓	✓





Flexible configuration of Smart Lockers

Available identification methods

Users can open lockers using the mobile application, website, QR code, RFID card, PIN code, or access screen.

One locker, many functions

Lockers have versatile applications and can serve multiple functions simultaneously. They can be used interchangeably by employees, guests, package delivery personnel, and facility managers. Each compartment can be individually configured for a different scenario.

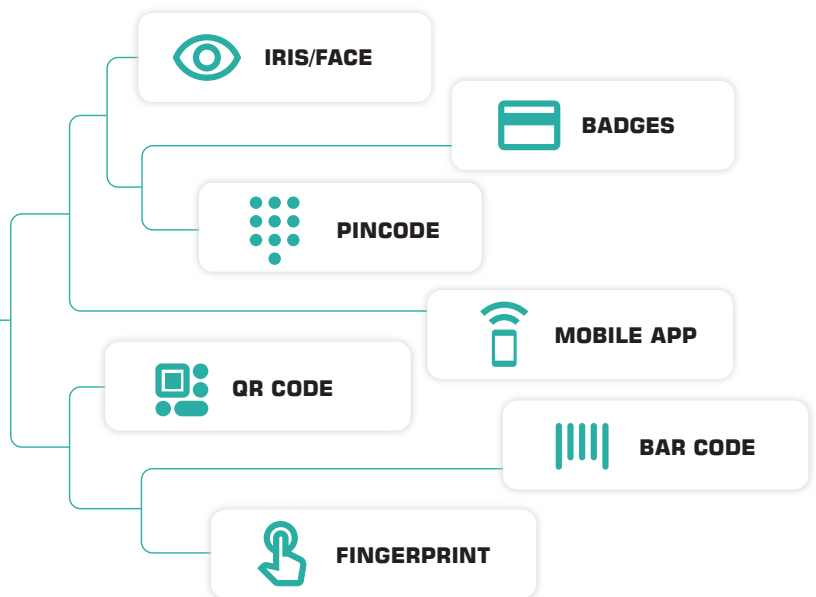

Smart Lockers

Earn with Smart Lockers:

- Limited personnel costs.
- Reduced costs of used tools thanks to identification of take outs.
- Renting lockers can be charged, from first hour or after exceeding a certain time.
- Possibility of locker reservation ONLINE (concerts, theaters, etc.).
- Possibility of selling items.
- 24/7 access.

Mobile application that offers numerous possibilities:



Locker status



ONLINE payment



Location



QR codes



General status



Statistics and charts



Settings and configuration



Company / user data

Rent a locker within 30 sec. and open it with your phone.



CONTRACT FURNITURE

With our furniture lines, we can comprehensively furnish any interior. You don't have to look for multiple suppliers. ALSANIT - one supplier for your investment.



RECEPTION DESKS

Representative, modern, modular.

Thanks to a comprehensive approach to equipping facilities, ALSANIT offers the possibility of creating receptions that will be consistent with the entire project of the investment.

available
colors

page 173 →



Reception DRAVA

MFC

18 mm

Spaciousness not only in form

Receptions with a simple shape, which strength lies in the use of three-dimensional cladding.

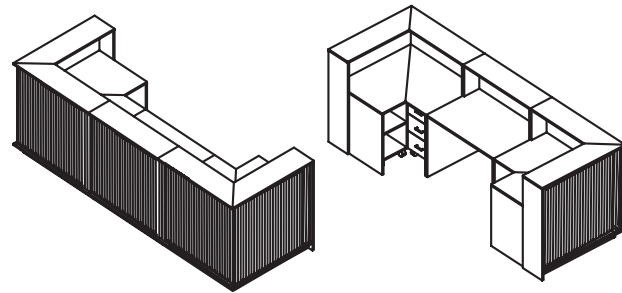
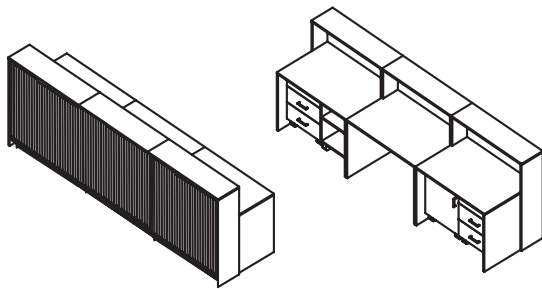
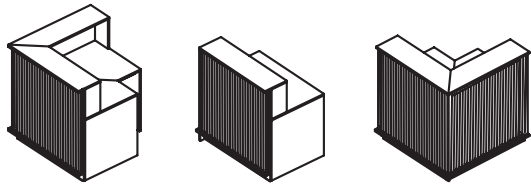
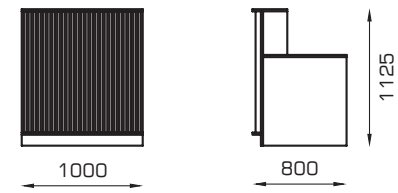

Reception VARTA

MFC

18 mm

The industrial visual effect.

Receptions where a metal mesh is used as a decorative element. It has a loft and industrial character.

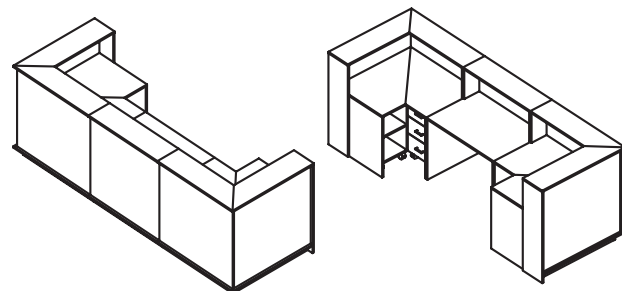
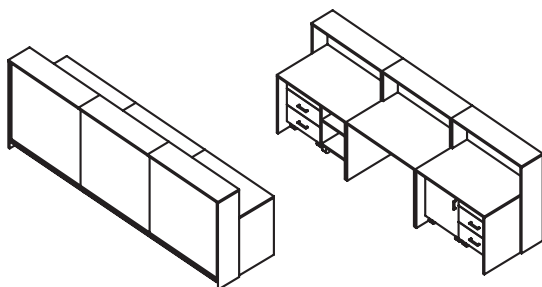
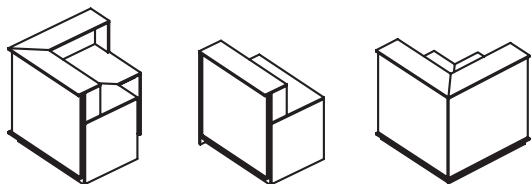
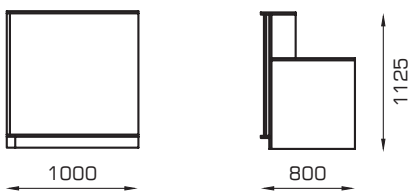
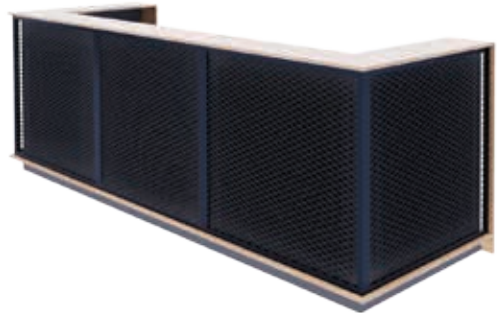

Reception REGA

HPL + MFC

10 mm

18 mm

Gentle and delicate shape

The form of the reception desk is a treat for demanding projects where attention to detail is paramount.

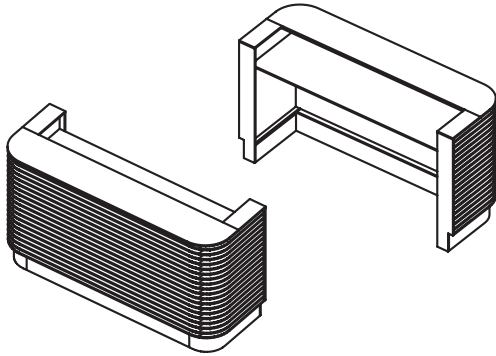
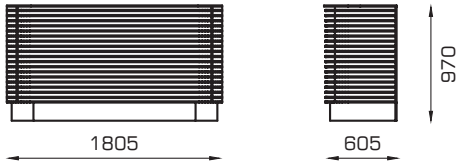

Reception VISTU

MFC

18 mm

Go for contrast

Receptions created from two contrasting blocks in color and size. Simple in form, striking in appearance.

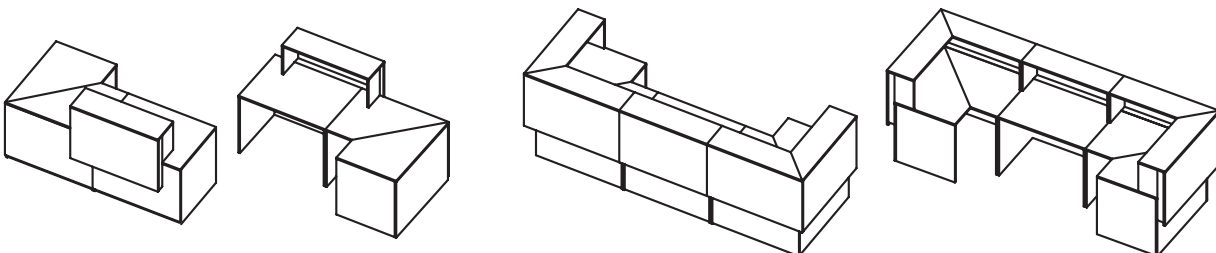
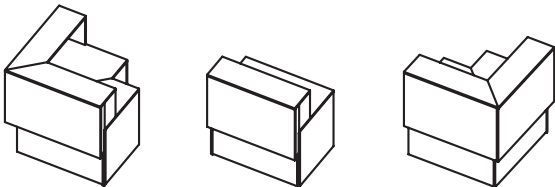
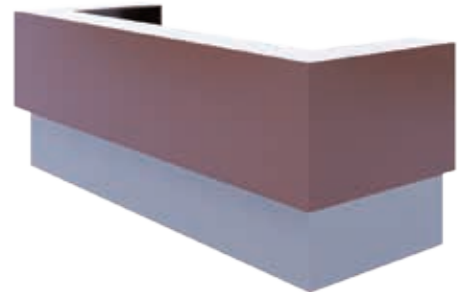
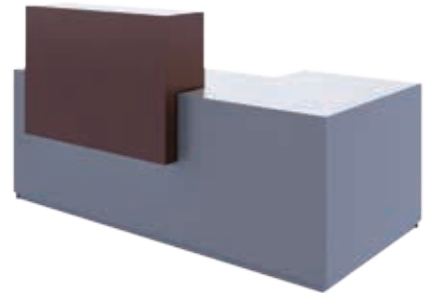
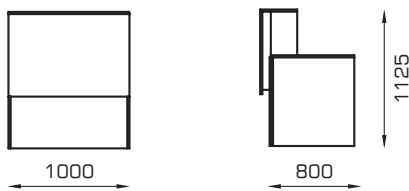

Reception SAN

HPL

10 mm

[← back](#)

[contact](#)

Smooth lines and lack of sharp angles

The quintessence of simplicity and functionality.

The possibility of adjusting the height of the countertop.

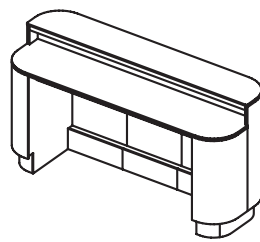
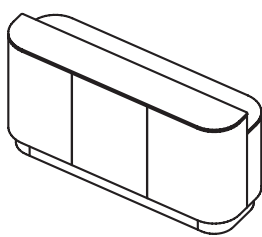
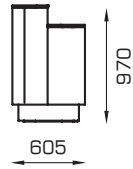
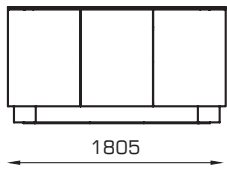

Reception SONA

HPL

10 mm

Avant-garde touch

Reception desk designed for unique interiors. The possibility of using materials with different patterns and structures.

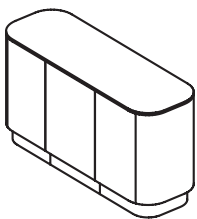
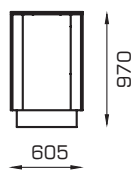
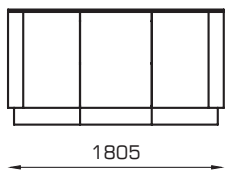



TABLES

Tables with various shapes and bases.

Diverse in shape and colors, sturdy and elegant. They will fit into any interior from an office to a fitness club. Available in configurations with wooden and metal legs.

available
colors

page 173 →



Table R2

HPL

10 mm

12 mm

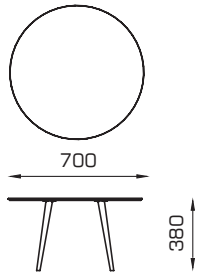
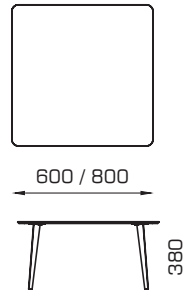

Table D2

HPL

10 mm

12 mm



[← back](#)

[contact](#)

Table 3L

HPL

10 mm

12 mm

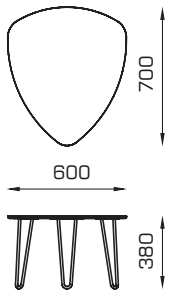

Table KITE

HPL

10 mm

12 mm

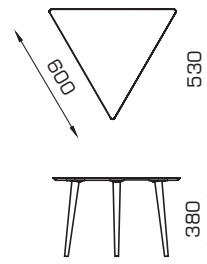

Table HIVE

HPL

10 mm

12 mm

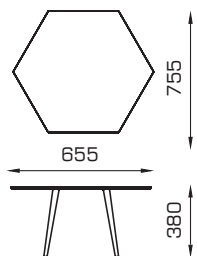
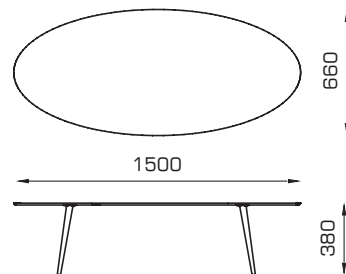

Table ELLIPSO

HPL

10 mm

12 mm





CHAIRS AND SOFAS

Upholstered chairs and sofas are an elegant addition to any room.

Upholstered furniture features a versatile design, suitable for prestigious interiors like hotel lobbies as well as eclectic, modern facilities.

The decors
are determined
individually



KLUBE

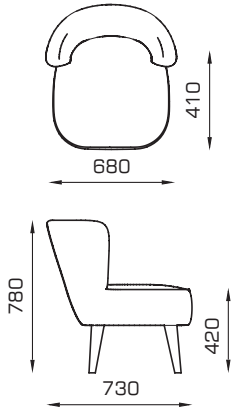

COMFY

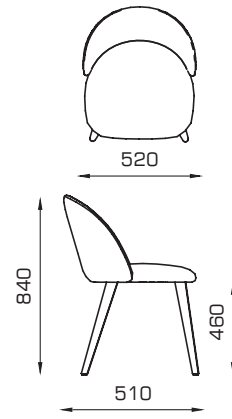

KLUBSO

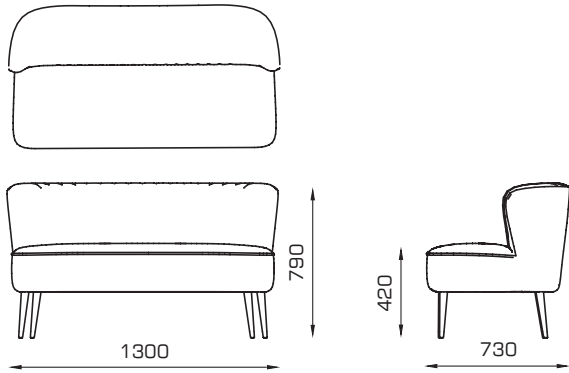

SOFIE

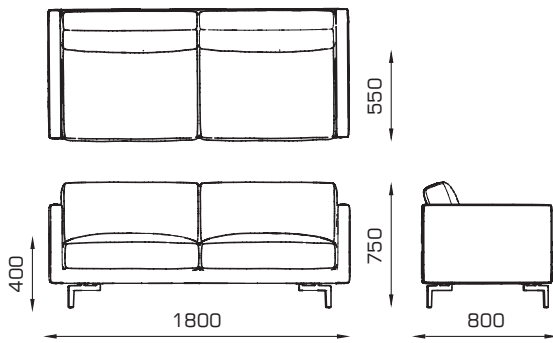

SITON

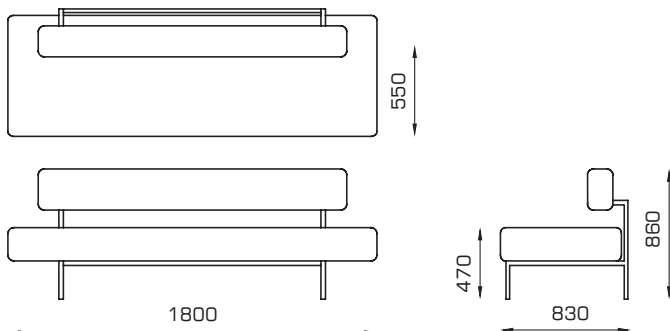



GRIDO

GRIDO offers an infinite palette of possibilities, allowing you to create unique spaces.

Fast assembly combined with aesthetic design makes the modular shelving system possible to adapt to the interior style or function it is intended for.

available
colors



page 173 →

GRIDO modular shelving

MFC

18 mm

[← back](#)

[contact](#)

Continuous effect without „double” profiles
Easy installation and re-arrangement.

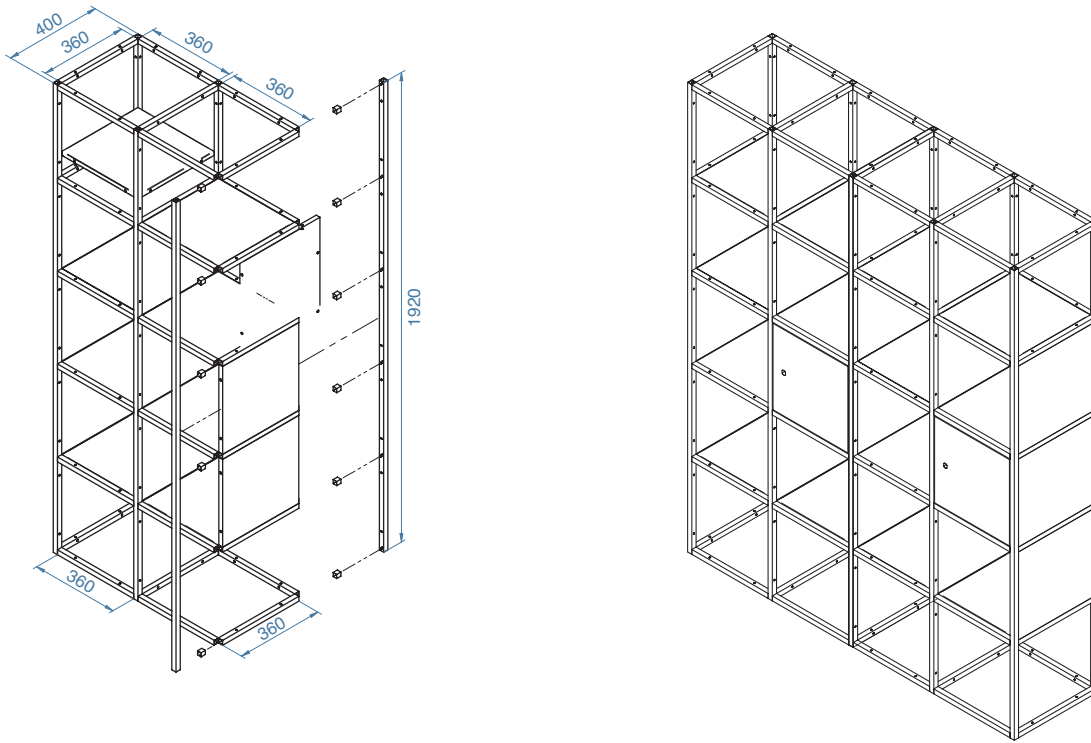

Example configuration

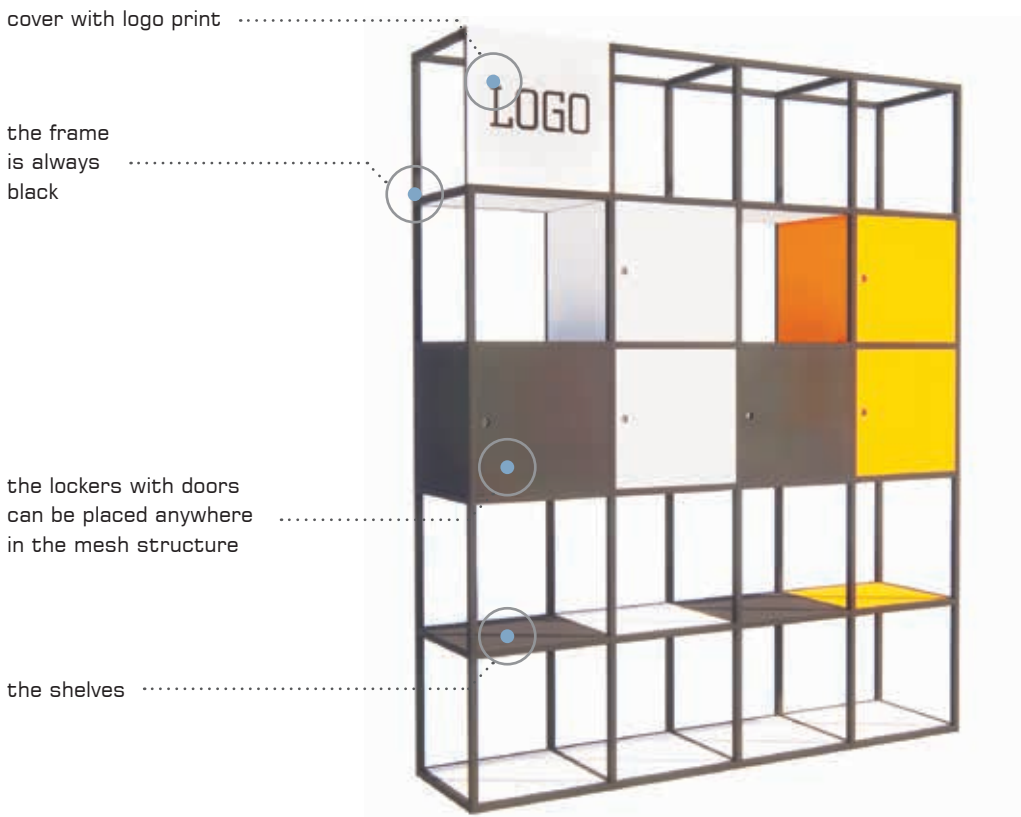



SHELVING

Easy assembly, universal application.

Functional shelves and cabinets serve not only for storage but also help in arranging stylish changing rooms, sports facilities, gyms, fitness clubs, offices, and workplaces. They are very versatile in their application and easy to assemble.

available
colors



page 173 →

S1

MFC

18 mm

[← back](#)

[contact](#)

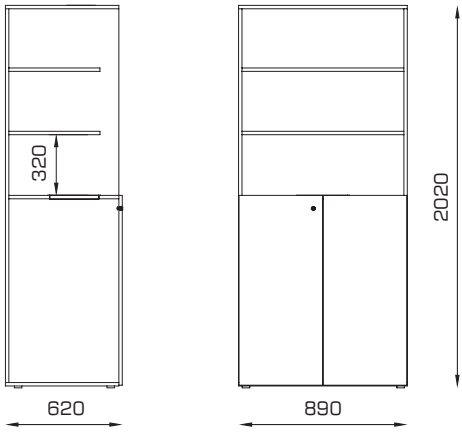

S2

MFC

18 mm



S3

MFC

18 mm

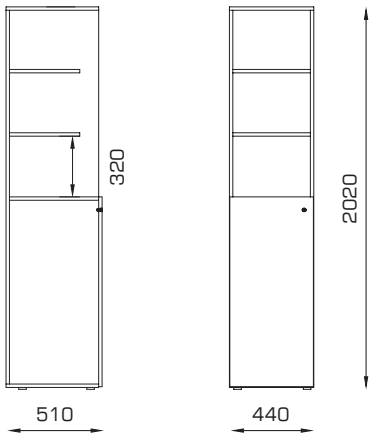

S4

MFC

18 mm

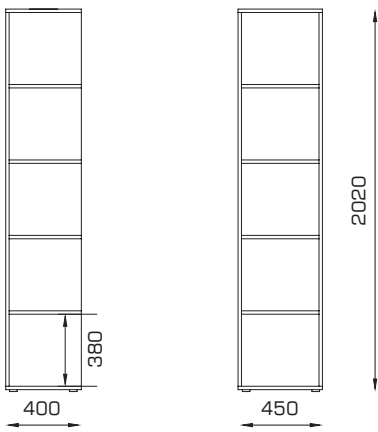

S5

MFC

18 mm

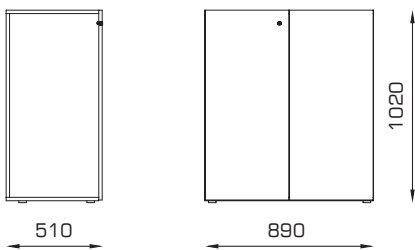

S6

MFC

18 mm

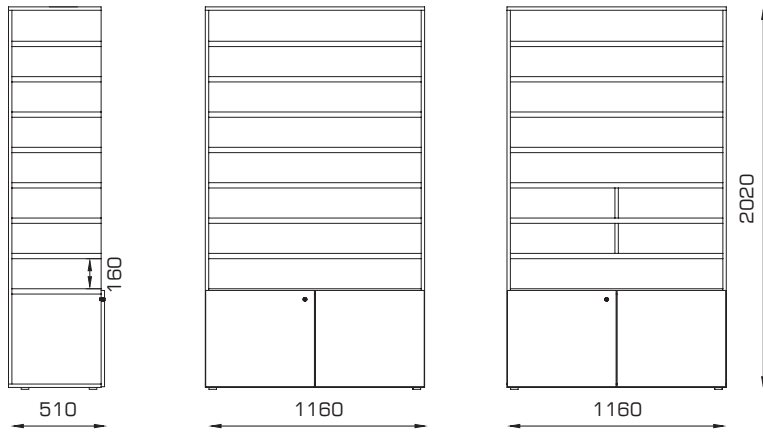

S7

MFC

18 mm

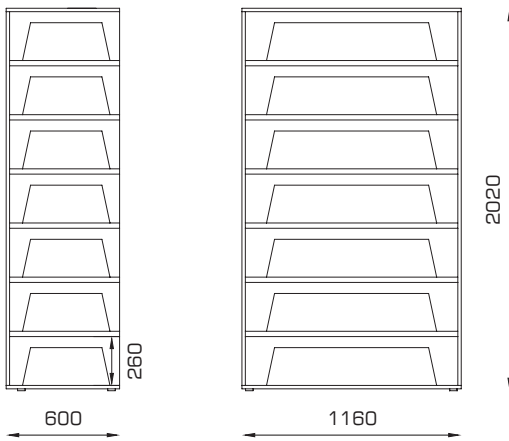

S8

MFC

18 mm

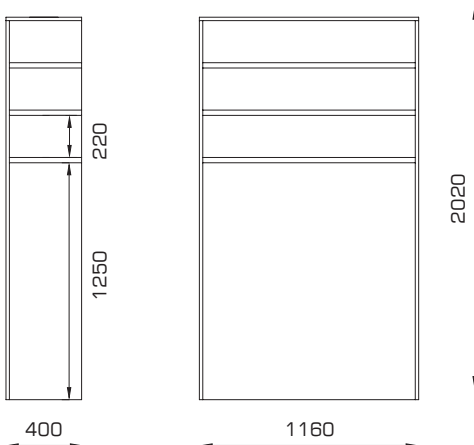



PARTITIONS

Elegant zoning of spaces in open-plan areas.

Partitions allow for easy arranging and dividing of space. Thanks to their lattice construction, they are light and subtle. This innovative solution has an extraordinary character.

available
colors

page 173 →



Partitions ALLEN

Delicate metal mesh.

[← back](#)

[contact](#)

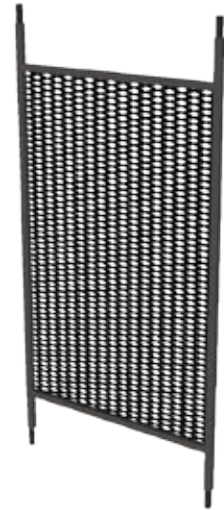
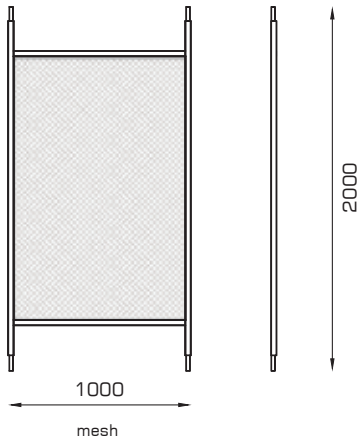

Partitions WOODY

Inspired by sun shading panels.

MFC

18 mm

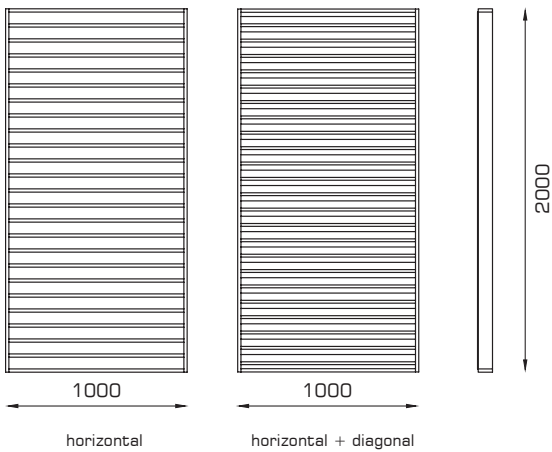

MFC

28 mm

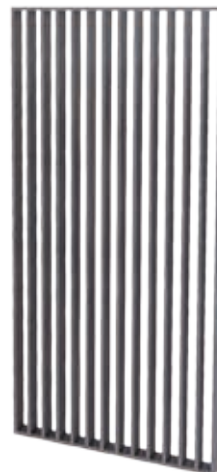
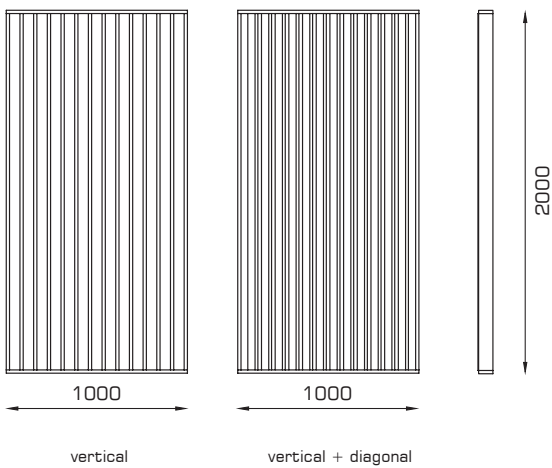



SLATS

Wall coverings that protect and decorate walls.

Produced in multiple sizes for the easiest fitting and assembly.

available colors

page 173 →



Slats - wall panels

MFC

18 mm

[← back](#)[contact](#)**Carefully crafted in every detail.**

An impressive wall finishing option.

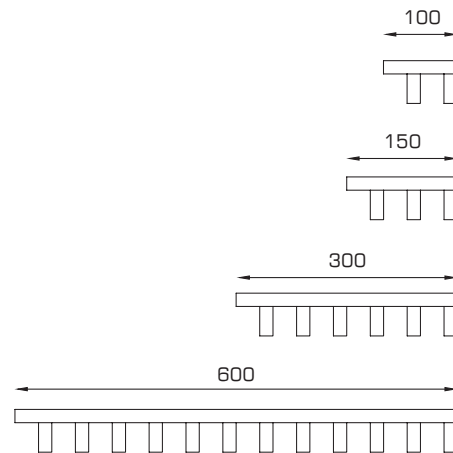
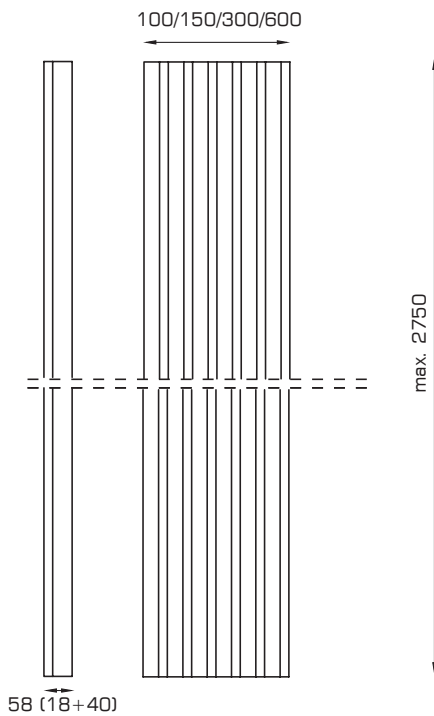

Example configurations

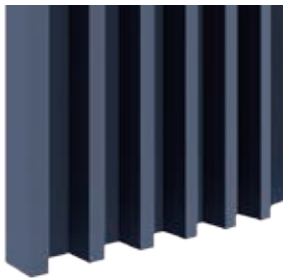

full anthracite



white on white



wood on white



VANITY

Small countertops designed for placing hair dryers, straighteners, and other small accessories.

Essential in every sports facility. Simple in design, with integrated mirror and a hole for hairdryer placement. A wide range of colors allows for matching with other interior elements.

available
colors



page 173 →

VANITY

MFC

18 mm

HPL

10 mm

12 mm

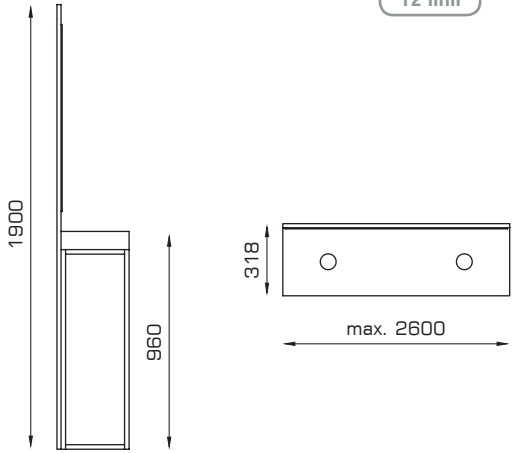

VANFLY



VANSUP



VANLEG



VANUPP



TOILET CUBICLES

We are the biggest Polish cubicle producer our products are most durable and set the market standards.



The SOLARI system is the perfect combination of durability and aesthetics at the best price.

Due to its versatility, it is the most popularly purchased sanitary cabin system in Poland

[table of content](#)

[← back](#)

[contact](#)

SOLARI

SOLARI

SOLARI cubicles made of hpl / mfc / sp

Available in:

- MFC** - Laminated chipboard
- HPL** - High Pressure Laminate
- SP** - Sandwich panels

Description:

The SOLARI cubicle system is a solution designed with users in mind, emphasizing both functionality and economy. For this purpose, ALSANIT designers have developed fittings using durable and aesthetic materials such as polyamide and aluminum.

The SOLARI system has become extremely popular and quickly gained the position of a bestseller among sanitary cubicle systems. It holds necessary approvals and certifications for industry.

Our systems have a CE certificate recognized throughout the EU.

The SOLARI system has been prepared for easy and quick self-assembly. All necessary instructions are included in the set.



only Torx screws are used



doors opening outward or inward



hinges with gravity self-closing



very high durability



taylor made to individual dimensions



Protected design
64932 (knob-lock)



Best selling system in Poland



CE certificate valid throughout the European Union



Fittings developed by ALSANIT are manufactured in Poland at the company headquarters



Production on CNC machines ensures precision and short lead times

Standard dimensions

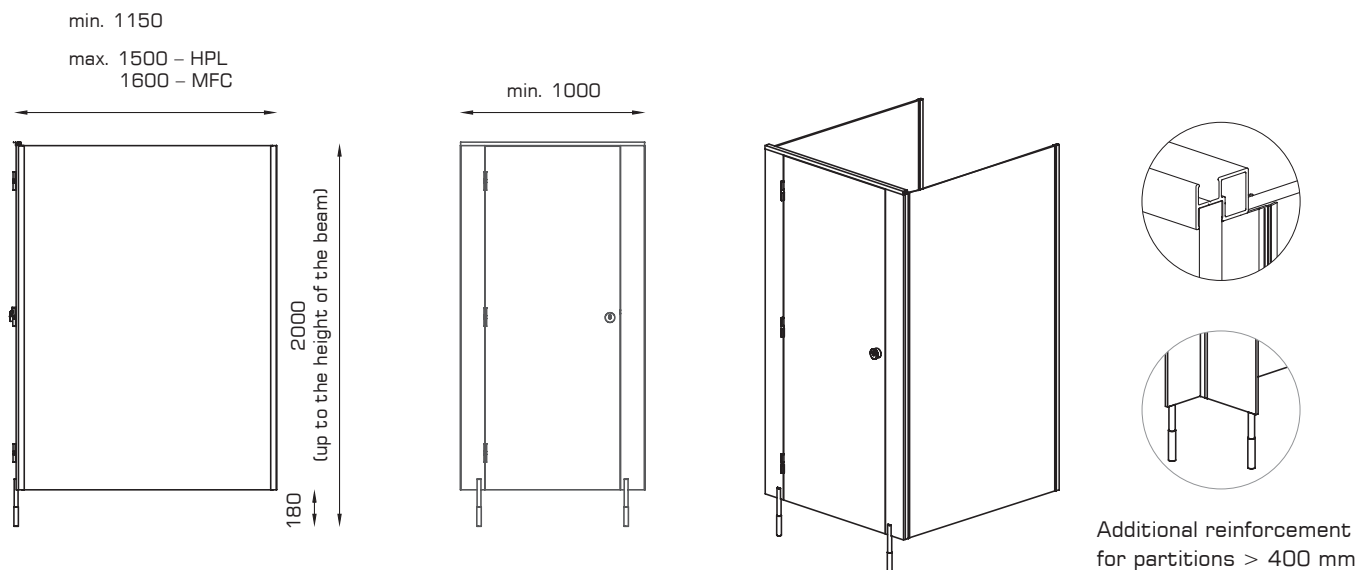

Standard equipment



SOLARI construction details

Construction details:

Hinges

- tested durability: 200,000 open/close cycles
- typically for ALSANIT, mounting to narrow edges of boards
- aluminum body with polyamide insert
- gravity self-closing
- first lubrication needed after several years of use
- optionally - hinges for internal doors not visible from the outside

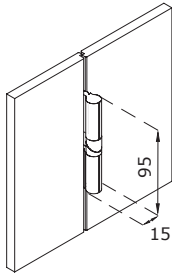

Knob-locks

- classic ALSANIT knob-locks made of aluminum and polyamide
- no maintenance required
- emergency opening possibility
- universal for left/right doors
- bolt rotation angle of 180°
- white-red occupancy indicator

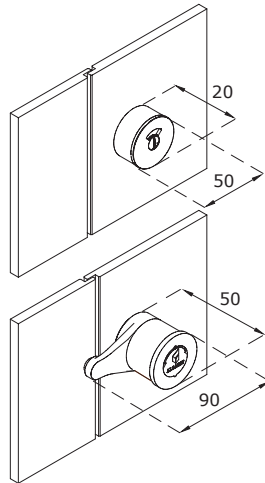

Support-legs

- aluminum with a stainless steel core
- for 10-18 mm panels mounted to the side of the panel, for 28 mm and thicker panels screwed into the core of the panel
- quick installation, only one hole in the floor for the bracket
- adjustment range +/- 20 mm
- optionally, a rosette mounted on two dowels, covered with a plate

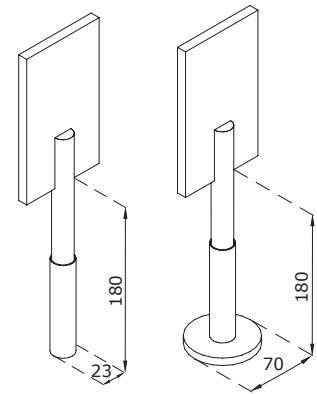

Types of panels available for the system:

MFC

Laminated chipboard

18 mm

28 mm

MFC is compressed under high temperature and pressure using binding agents with wood chips. The top layer is a decorative melamine coating.

- edges are finished with durable edging using HOT-AIR technology (glueless)
- suitable for rooms with normal humidity

Fire classification: Ds1d0



A solution for door frame for MFC boards



Support leg mounted frontally for 18 mm boards



Support leg screwed into the core for 28 mm boards



Top-mounted beam



Wall and partition mounting

HPL

High pressure laminate

10 mm

12 mm

HPL (High Pressure Laminate) - cellulose fibers saturated with resin and compressed under high pressure. The material is 100% waterproof and its properties are consistent throughout the entire board cross-section.

- milled edges-black core of the board is visible
- for rooms with high humidity

Fire classification: Cs2d0 - 10 mm, Bs1d0 - 12 mm (option)



A solution for door frame for HPL boards



Support leg mounted frontally



Top-mounted beam



Wall and partition mounting

SP

Sandwich panels

36 mm

Panels with a total thickness of 36 mm - feature an aluminum frame filled with foamed polystyrene, 28 mm thick, with outer layers consisting of 4 mm HPL.

- excellent rigidity and aesthetics
- ideal for full-height installations
- provide the best soundproofing

Fire classification: Es1d0



A solution for door frame for SP boards



Support leg screwed into the core



Rear-mounted beam



Possibility of using a handle



Concealed mounting for walls and partitions



Beauty, prestige, precision - these are the key features of the PERSEI system.

We have achieved them through the highest quality fittings specially designed by ALSANIT's engineers.



[table of content](#)

[← back](#)

[contact](#)

PERSEI

PERSEI

PERSEI cubicles made of hpl / mfc / sp

Available in:

- MFC** - Laminated chipboard
- HPL** - High Pressure Laminate
- SP** - Sandwich panels





Description:

Brushed steel has become a popular element in modern architecture. The PERSEI system, specially designed by ALSANIT's engineers, features ergonomic and elegant fittings with a brushed steel finish.

This versatile system is compatible with various types of panels. Aluminum profiles with a delicate design securely hold the structure together, providing rigidity while maintaining a sense of exceptional lightness. The PERSEI system is an excellent choice for projects where elegance and functionality go hand in hand. The

reinforcing headrail is typically concealed behind the cabin doors, adding elegance and aesthetics to the fronts.

The system can be installed independently according to the provided instructions or with the assistance of an authorized ALSANIT installation team, ensuring convenience and confidence in proper assembly.

-  only Torx screws are used
-  doors opening outward or inward
-  hinges with gravity self-closing
-  very high durability
-  tailor made to individual dimensions



CE certificate valid throughout the European Union



Fittings with a brushed steel finish



Fittings developed by ALSANIT are manufactured in Poland at the company headquarters



Production on CNC machines ensures precision and short lead times

Standard dimensions

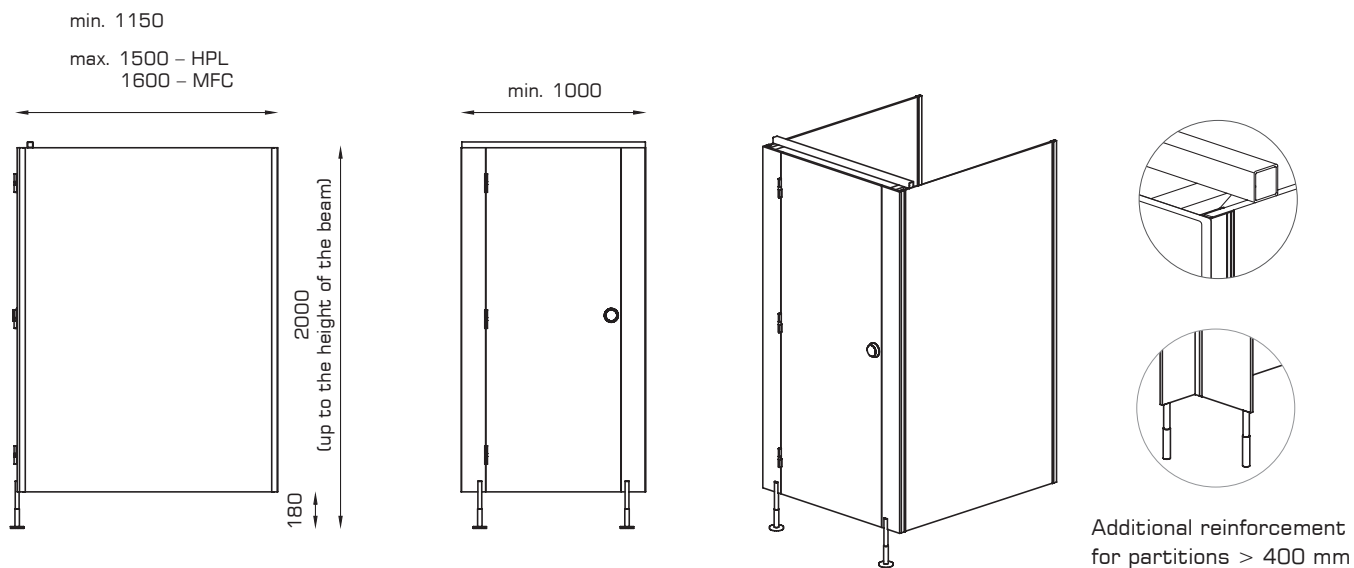

Standard equipment

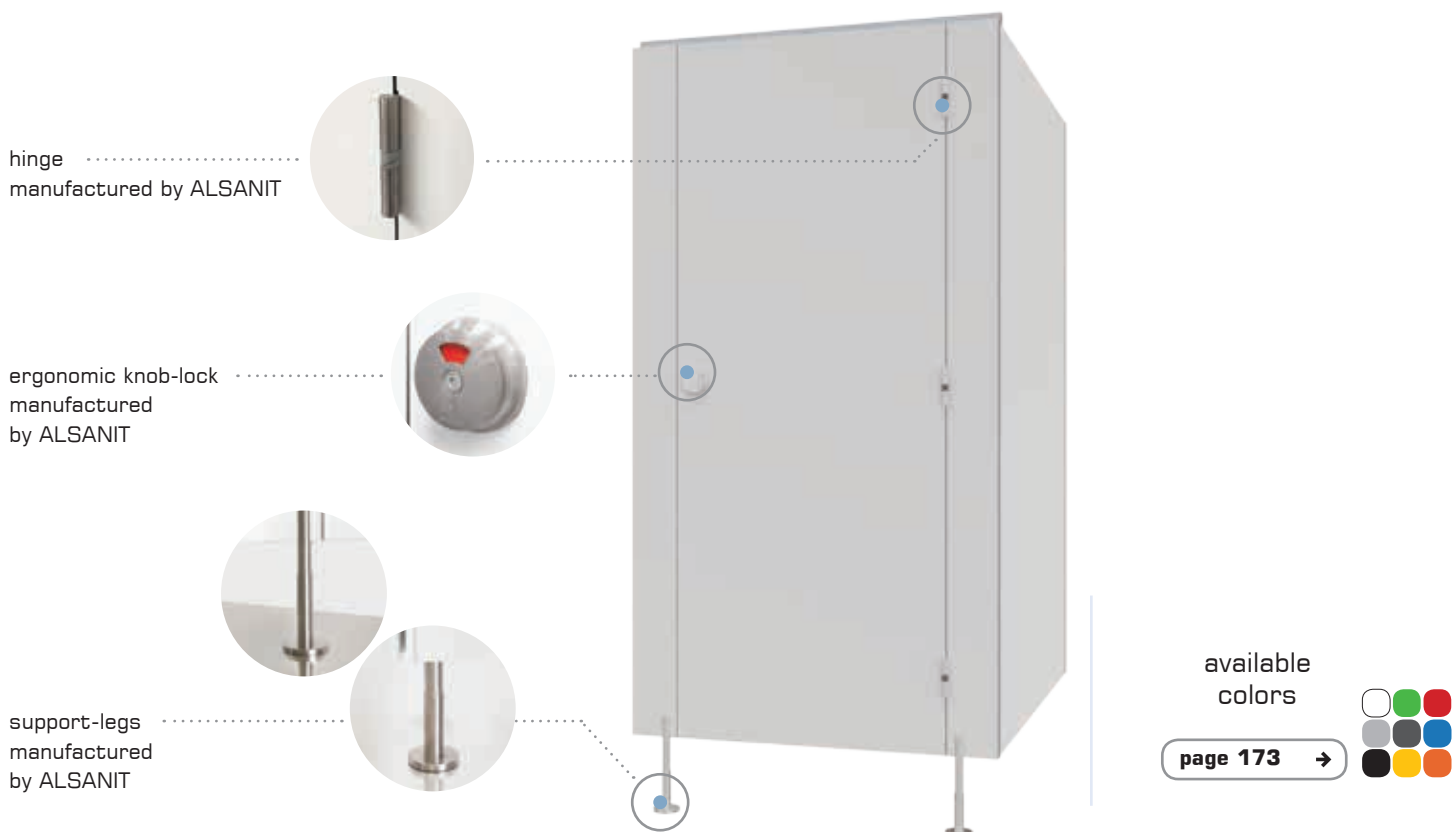

PERSEI construction details

Construction details:

Hinges

- tested durability: 200,000 open/close cycles
- typically for ALSANIT, mounted to narrow edges of panels
- made of brushed steel with a polyamide insert
- gravity self-closing
- minimalist appearance
- optionally - hinges for internal doors not visible from the outside

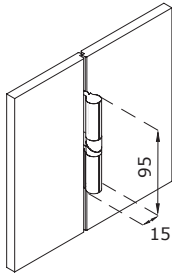

Knob-locks

- elegant, ergonomic and highly durable
- emergency opening capability
- universal for left/right doors
- bolt rotation angle of 360°
- „click” every 90°
- easy to use, including for individuals with disabilities
- white-red occupancy indicator

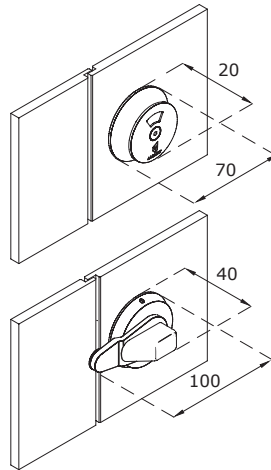

Support-legs

- made of brushed steel
- ensure easy leveling of partitions
- for 10-18 mm boards mounted to the side of the board, for 28 mm and thicker boards screwed into the core
- adjustment range +/- 20 mm
- rosette mounted on two dowels, covered with a plate

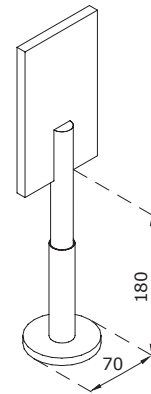

Types of panels available for the system:

MFC

Laminated chipboard

18 mm

28 mm

MFC is compressed under high temperature and pressure using binding agents with wood chips. The top layer is a decorative melamine coating.

- edges are finished with durable edging using HOT-AIR technology (glueless)
- suitable for rooms with normal humidity

Fire classification: Ds1d0



A solution for door frame for MFC boards



Support leg mounted frontally for 18 mm boards



Support leg screwed into the core for 28 mm boards



Rear-mounted beam



Wall and partition mounting

HPL

High pressure laminate

10 mm

12 mm

HPL (High Pressure Laminate) - cellulose fibers saturated with resin and compressed under high pressure. The material is 100% waterproof and its properties are consistent throughout the entire board cross-section.

- milled edges-black core of the board is visible
- for rooms with high humidity

Fire classification: Cs2d0 - 10 mm, Bs1d0 - 12 mm (option)



A solution for door frame for HPL boards



Support leg mounted frontally



Rear-mounted beam



Wall and partition mounting

SP

Sandwich panels

36 mm

Panels with a total thickness of 36 mm - feature an aluminum frame filled with foamed polystyrene, 28 mm thick, with outer layers consisting of 4 mm HPL.

- excellent rigidity and aesthetics
- ideal for full-height installations
- provide the best soundproofing

Fire classification: Es1d0



A solution for door frame for SP boards



Support leg screwed into the core



Rear-mounted beam



Possibility of using a handle



Concealed mounting for walls and partitions



AQUARI is a combination of an innovative **SAFE FINGERS solution and exceptional design.**

A universal system showcasing classic elegance derived from simple lines created by aluminum profiles.

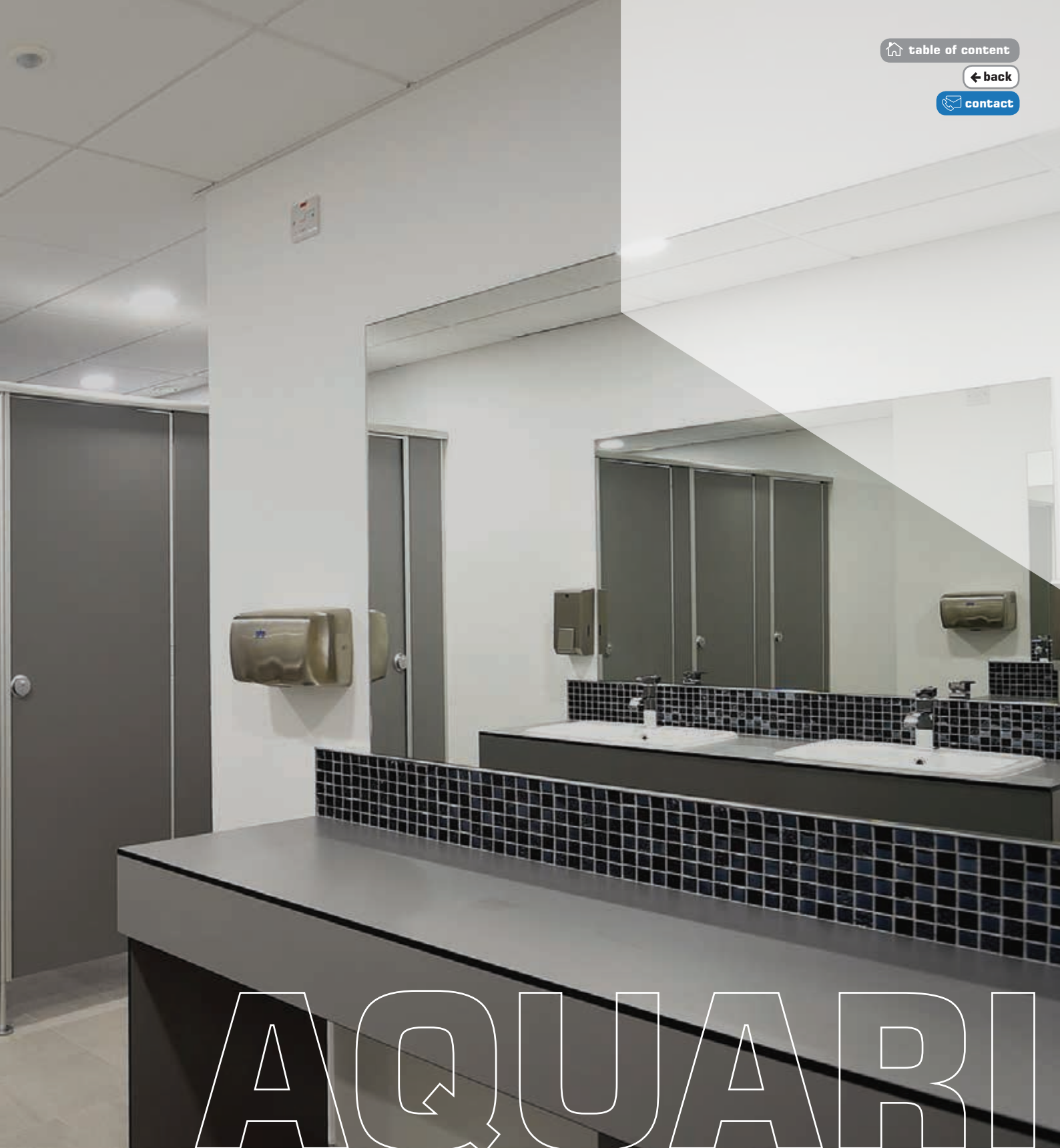

AQUARI

AQUARI cubicles made of hpl / mfc

Available in:

MFC - Laminated chipboard





HPL - High Pressure Laminate

Description:

The AQUARI system is proof that innovation in the field of sanitary cabins is possible. AQUARI represents an approach to our previously developed products - continuous improvement aimed at delivering leading solutions.

The most intriguing element of the AQUARI system is the hinge hidden in the door frame profile. This solution ensures an aesthetic appearance and protects against potential collisions - finger trapping between the door leaf and the frame. The cabin support is mounted in line

with the frame profiles, creating a cohesive and harmonious whole. The AQUARI system is a combination of the highest quality materials, innovative solutions, and original design. These solutions have been patent protected.

-  only Torx screws are used
-  doors opening outward or inward
-  hinges with gravity self-closing
-  very high durability
-  tailor made to individual dimensions



Patent
P. 425699
(hidden hinge)



Patented Safe Fingers solution



CE certificate valid throughout the European Union



Aluminum fittings



Fittings developed by ALSANIT are manufactured in Poland at the company headquarters



Production on CNC machines ensures precision and short lead times

Standard dimensions

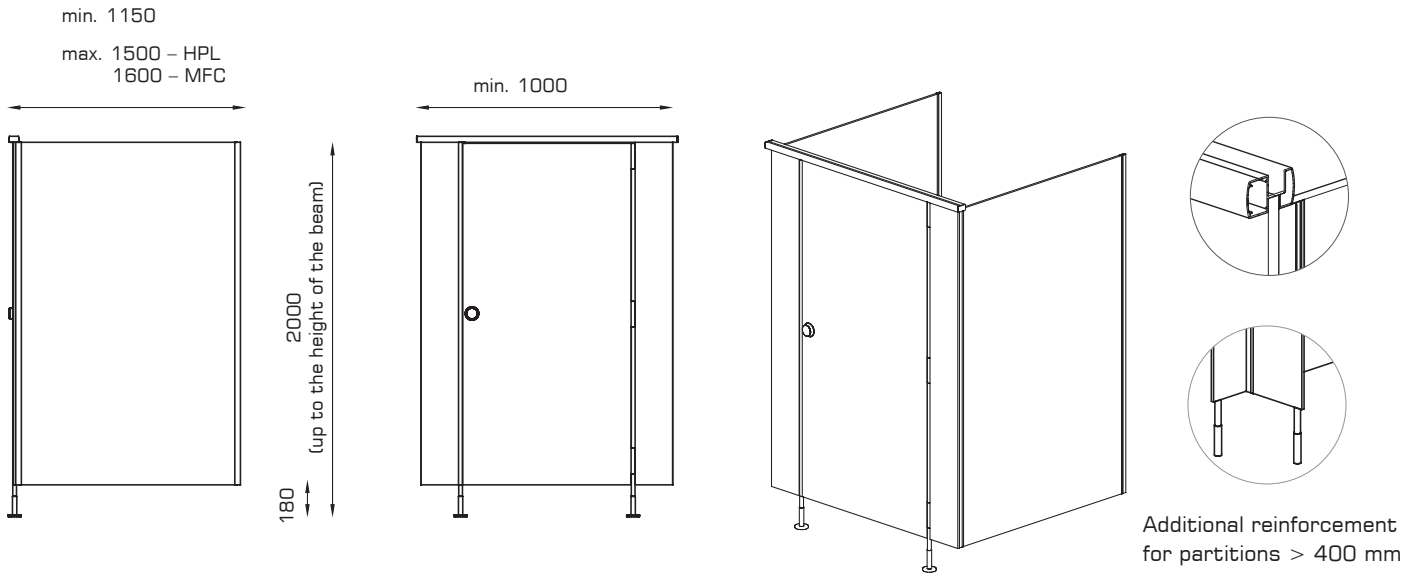

Standard equipment

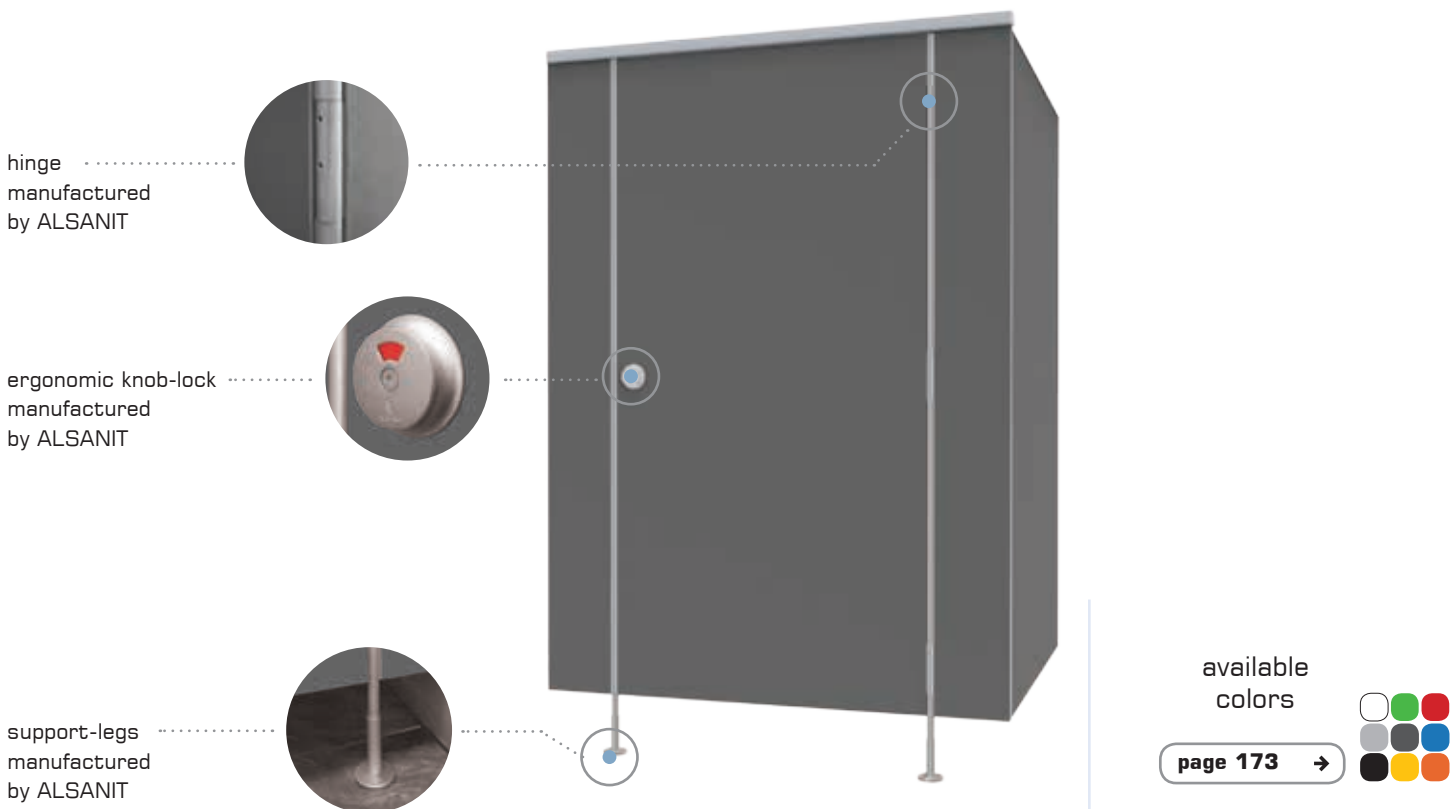

AQUARI high columns

Standard dimensions

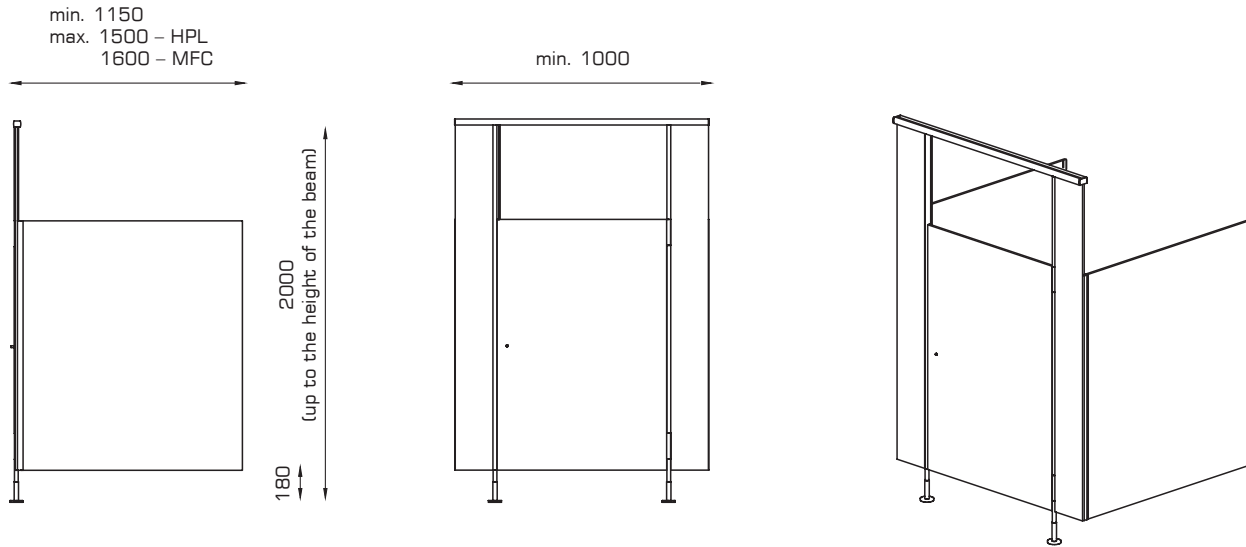

**optional -
custom handles**



safe hinge
manufactured by ALSANIT



Option - engraving (HPL)
made
on CNC machine

support-legs
manufactured
by ALSANIT

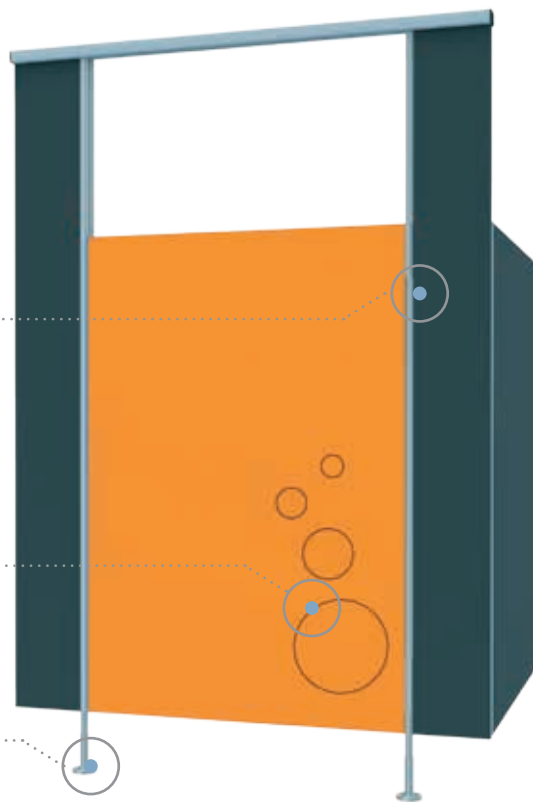

available
colors

page 173 →



Standard dimensions

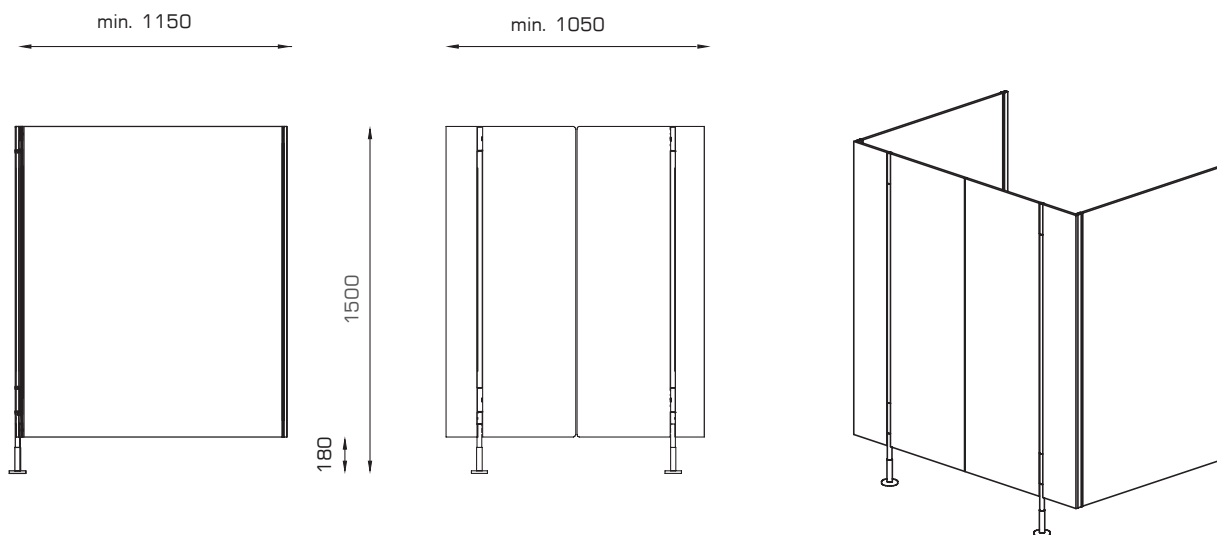

safe hinge
manufactured by ALSANIT



support-legs
manufactured by ALSANIT

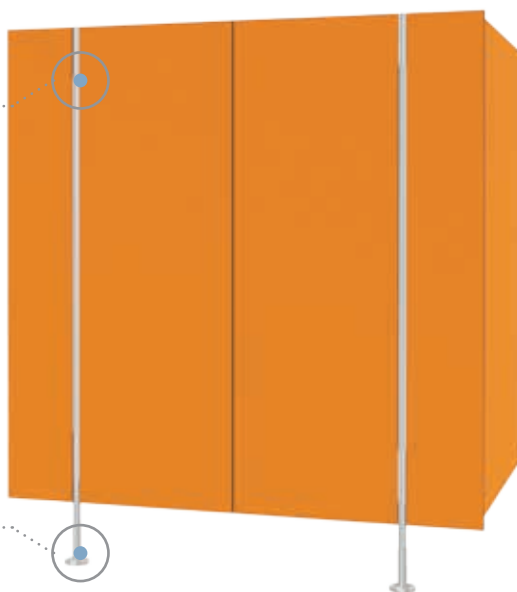

available
colors

page 173 →



AQUARI construction details

Construction details:

Hinges

- „safe fingers” system - protects fingers from being pinched
- tested durability: 200,000 open/close cycles
- hidden in aluminum profiles
- minimalist appearance
- with gravity self-closing function

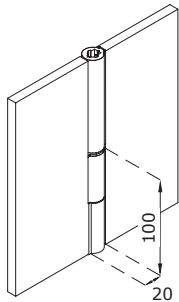

Knob-locks

- aluminum finish
- emergency opening capability
- universal for left/right doors
- Bolt rotation angle of 360°
- „click” every 90°
- easy to use, also for disabled individuals
- white-red occupancy indicator
- optionally available in preschool cabins

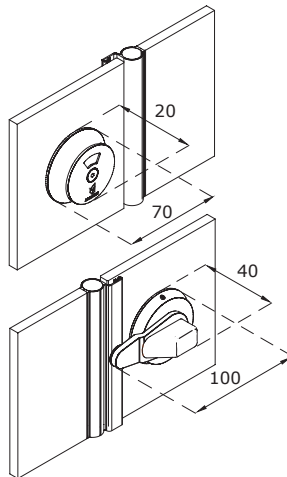

Support-legs

- mounted in the door frame profile in line with the hinges
- ensure easy leveling of partitions
- aluminum with a stainless steel core
- adjustment range +/- 20 mm
- rosette mounted on two dowels, covered with a plate

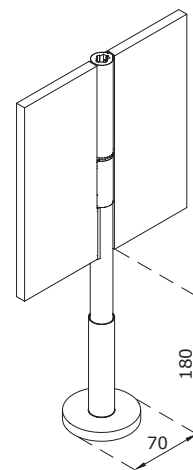

Types of panels available for the system:

MFC

Laminated chipboard

18 mm

MFC is compressed under high temperature and pressure using binding agents with wood chips. The top layer is a decorative melamine coating.

- edges are finished with durable edging using HOT-AIR technology (glueless)
- suitable for rooms with normal humidity

Fire classification: Ds1d0



A solution for door frame



Integrated support leg with the profile



Top-mounted beam (in saloon cubicles - no beam)

HPL

High pressure laminate

10 mm

12 mm

HPL (High Pressure Laminate) - cellulose fibers saturated with resin and compressed under high pressure. The material is 100% waterproof and its properties are consistent throughout the entire board cross-section.

- milled edges-black core of the board is visible
- for rooms with high humidity

Fire classification: Cs2d0 - 10 mm, Bs1d0 - 12 mm (option)



A solution for door frame



Integrated support leg with the profile



Top-mounted beam (in saloon cubicles - no beam)

„Safe fingers” solution

We have developed a unique solution which involves placing the hinge mechanism inside closed profiles to provide additional protection for hands from injury. The features of the system are summarized below:

- hinges are hidden within the door frame profiles, preventing fingers from being trapped between the door leaf and the frame,
- the hinge self-closing does not have a spring that could hit a child when the door is pulled,
- doors close due to gravity force - an extremely safe and reliable solution,
- this solution has been filed for patent protection and is produced exclusively by ALSANIT in Poland.

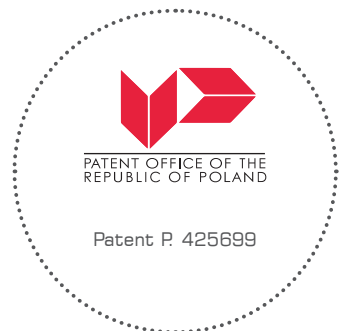



We offer the LIFT system to clients who do not use standard solutions.

So that each room has its own unique, difficult-to-replicate style.



LIFT

LIFT cubicles made of mfc / hpl / sp

Available in:

- MFC** - Laminated chipboard
- HPL** - High Pressure Laminate
- SP** - Sandwich panels

Description:

The LIFT cabins are a unique architectural solution for sanitary spaces where design plays a crucial role. LIFT is a line of cabins characterized by a recessed leg and an invisible reinforcing profile. From the front, this creates the impression that the cabins are suspended in the air, inspiring the name of this unique system.

LIFT cabins offer not only aesthetics but also solidity and durability, guaranteeing long-term use and maintaining an elegant appearance for many years.

The visual consistency of the project concept and the emphasis on cleanliness and hygiene are key elements that translate into positive user experiences.

The effect of floating cabins perfectly complements the prestige and elegance of facilities such as office buildings, hotels, or shopping centers. It is an excellent solution wherever interiors require exceptional style and a unique character.



only Torx screws are used



doors opening outward or inward



hinges with gravity self-closing



very high durability



tailor made to individual dimensions



Impressive impression of lightness



CE certificate valid throughout the European Union



Fittings with a brushed steel finish



Fittings developed by ALSANIT are manufactured in Poland at the company headquarters



Production on CNC machines ensures precision and short lead times

Standard dimensions

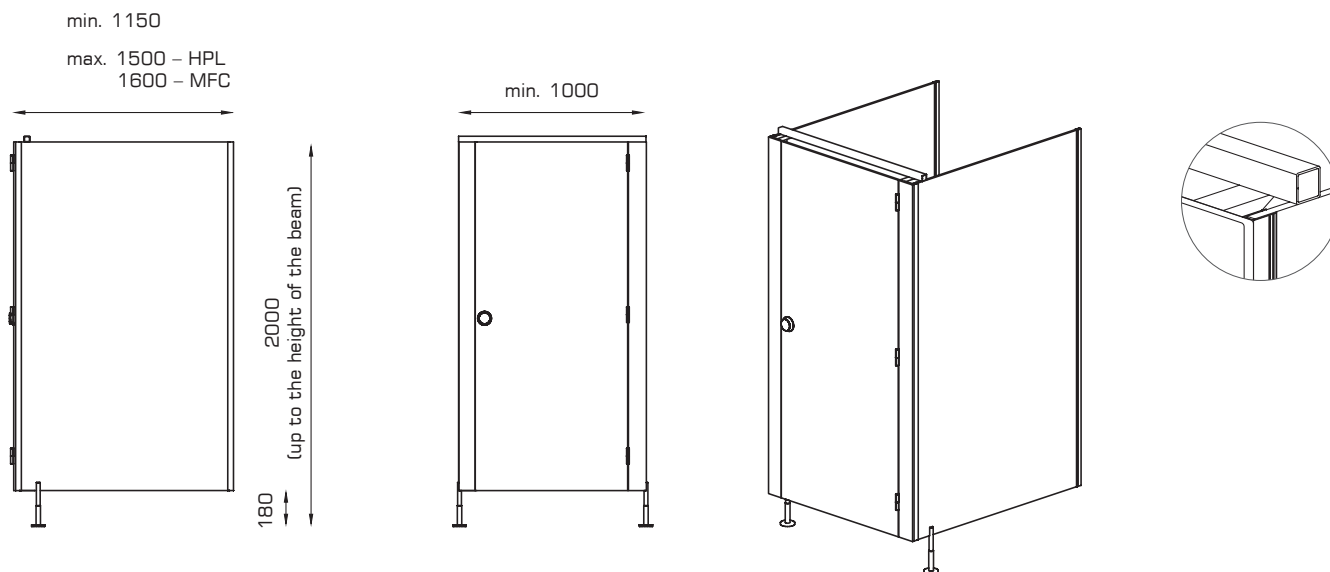

Standard equipment

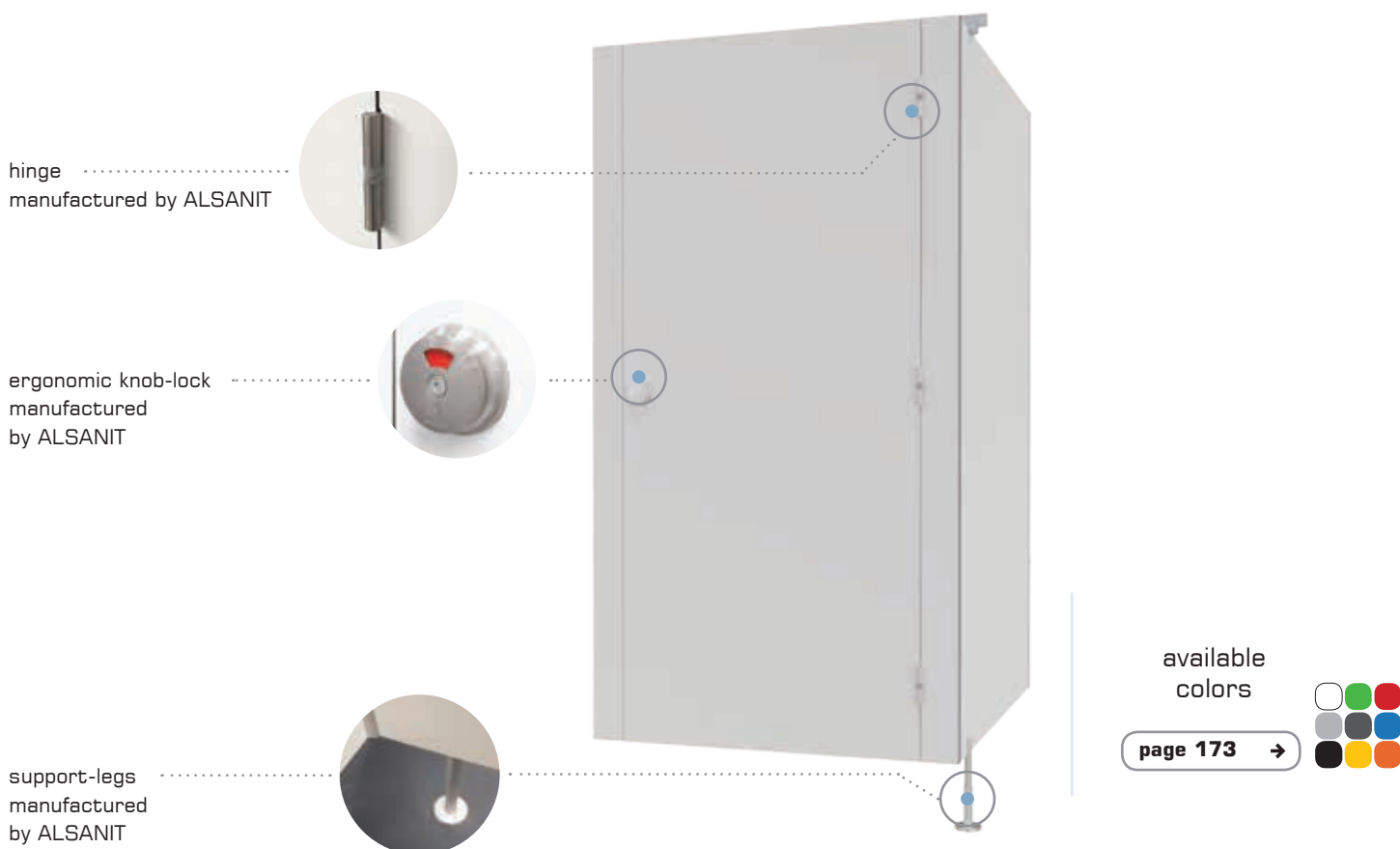

LIFT construction details

Construction details:

Hinges

- tested durability: 200,000 open/close cycles
- typically for ALSANIT, mounted to narrow edges of panels
- made of brushed steel with a polyamide insert
- gravity self-closing
- minimalist appearance
- optionally - hinges for internal doors not visible from the outside

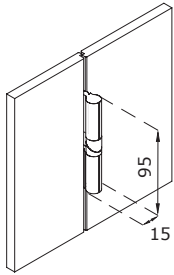

Knob-locks

- elegant, ergonomic and highly durable
- emergency opening capability
- universal for left/right doors
- bolt rotation angle of 360°
- „click” every 90°
- easy to use, including for individuals with disabilities
- white-red occupancy indicator

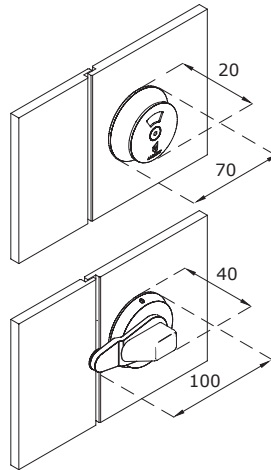

Support-legs

- "hanging" cubicle effect
- made of brushed steel
- ensure easy leveling of partitions
- for 10-18 mm boards mounted to the side of the board, for 28 mm and thicker boards screwed into the core
- adjustment range +/- 20 mm
- rosette mounted on two dowels, covered with a plate

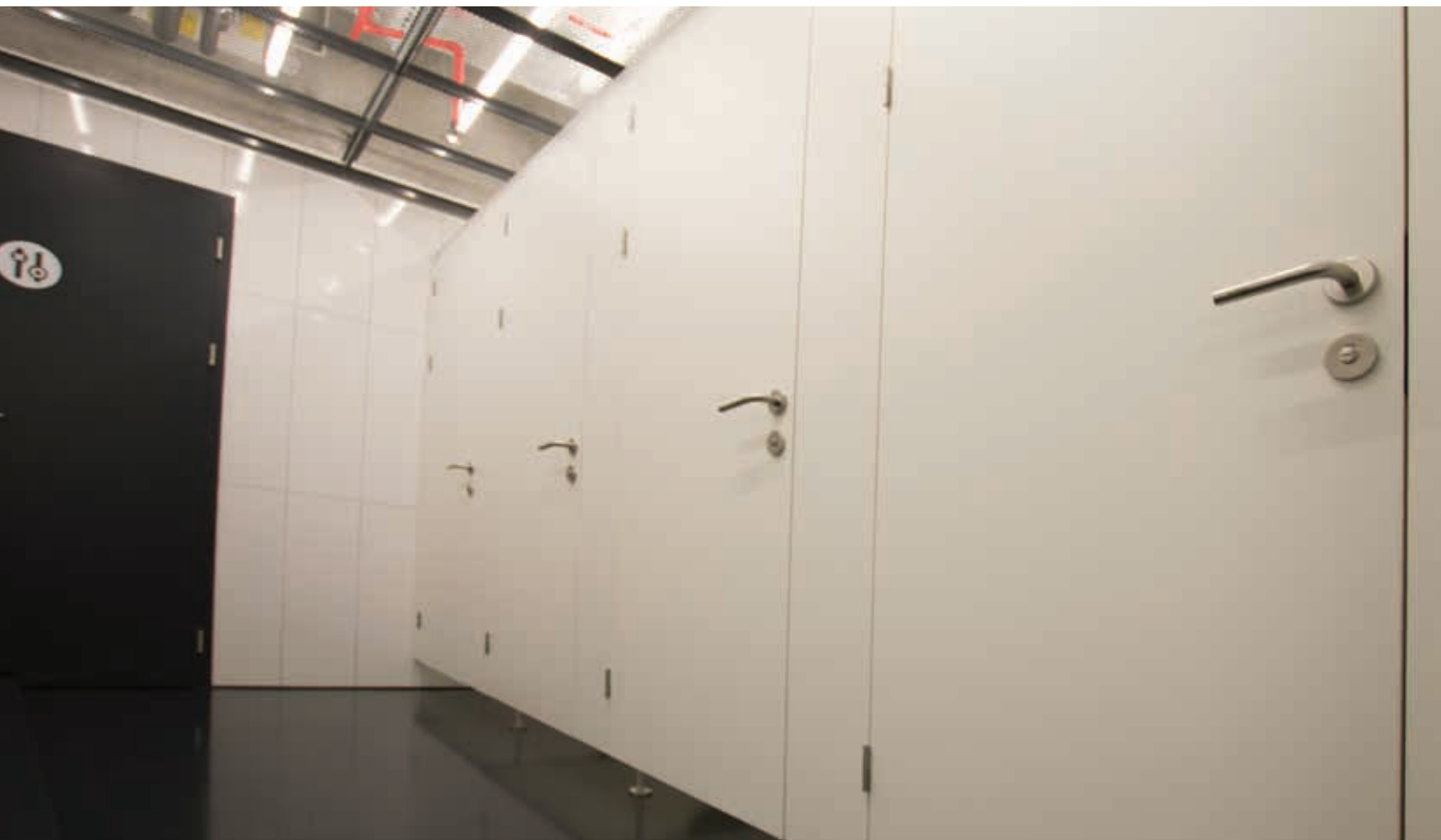
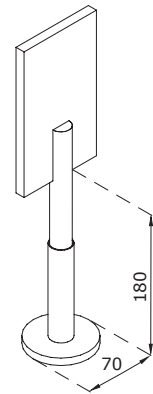

Types of panels available for the system:

MFC

Laminated chipboard

18 mm

28 mm

MFC is compressed under high temperature and pressure using binding agents with wood chips. The top layer is a decorative melamine coating.

- edges are finished with durable edging using HOT-AIR technology (glueless)
- suitable for rooms with normal humidity

Fire classification: Ds1d0



A solution for door frame for MFC boards



Support leg mounted on a partition wall



Rear-mounted beam



Wall and partition mounting

HPL

High pressure laminate

10 mm

12 mm

HPL (High Pressure Laminate) - cellulose fibers saturated with resin and compressed under high pressure. The material is 100% waterproof and its properties are consistent throughout the entire board cross-section.

- milled edges-black core of the board is visible
- for rooms with high humidity

Fire classification: Cs2d0 - 10 mm,
Bs1d0 - 12 mm (option)



A solution for door frame for HPL boards



Support leg mounted on a partition wall



Rear-mounted beam



Wall and partition mounting

SP

Sandwich panels

36 mm

Panels with a total thickness of 36 mm - feature an aluminum frame filled with foamed polystyrene, 28 mm thick, with outer layers consisting of 4 mm HPL.

- excellent rigidity and aesthetics
- ideal for full-height installations
- provide the best soundproofing

Fire classification: Es1d0



A solution for door frame for SP boards



Support leg screwed into the core



Rear-mounted beam



Possibility of using a handle



Concealed mounting for walls and partitions



ALTUS, full-height sanitary partitions that improve user comfort and the aesthetics of the room.

Optimally utilize available space, organizing it and improving its usability.

[table of content](#)

[← back](#)

[contact](#)



ALTUS

ALTUS

ALTUS full-height cubicles

Available in:

- MFC** - Laminated chipboard
- HPL** - High Pressure Laminate
- SP** - Sandwich panels





Description:

Full-height toilet cabins are becoming increasingly popular because they not only guarantee privacy but also allow for better coherence between sanitary interiors and the overall appearance of the building. This makes this type of WC cubicles increasingly applicable in newly constructed facilities.

The design of full-height cabins is executed considering the space and character of the rooms. However, proper preparation and finishing of the rooms before in-

stallation are important, as this system is entirely prepared at the ALSANIT factory and maintains small dimensional tolerances. Any deviations from the specified dimensions may hinder installation.

Due to its proven construction and high-quality materials, the ALTUS system performs excellently in restrooms with high traffic volume.

-  only Torx screws are used
-  doors opening outward or inward
-  hinges with gravity self-closing
-  very high durability
-  tailor made to individual dimensions



Full-height cabins



CE certificate valid throughout the European Union



Fittings with a brushed steel finish



Fittings developed by ALSANIT are manufactured in Poland at the company headquarters



Production on CNC machines ensures precision and short lead times

Standard dimensions



Standard equipment

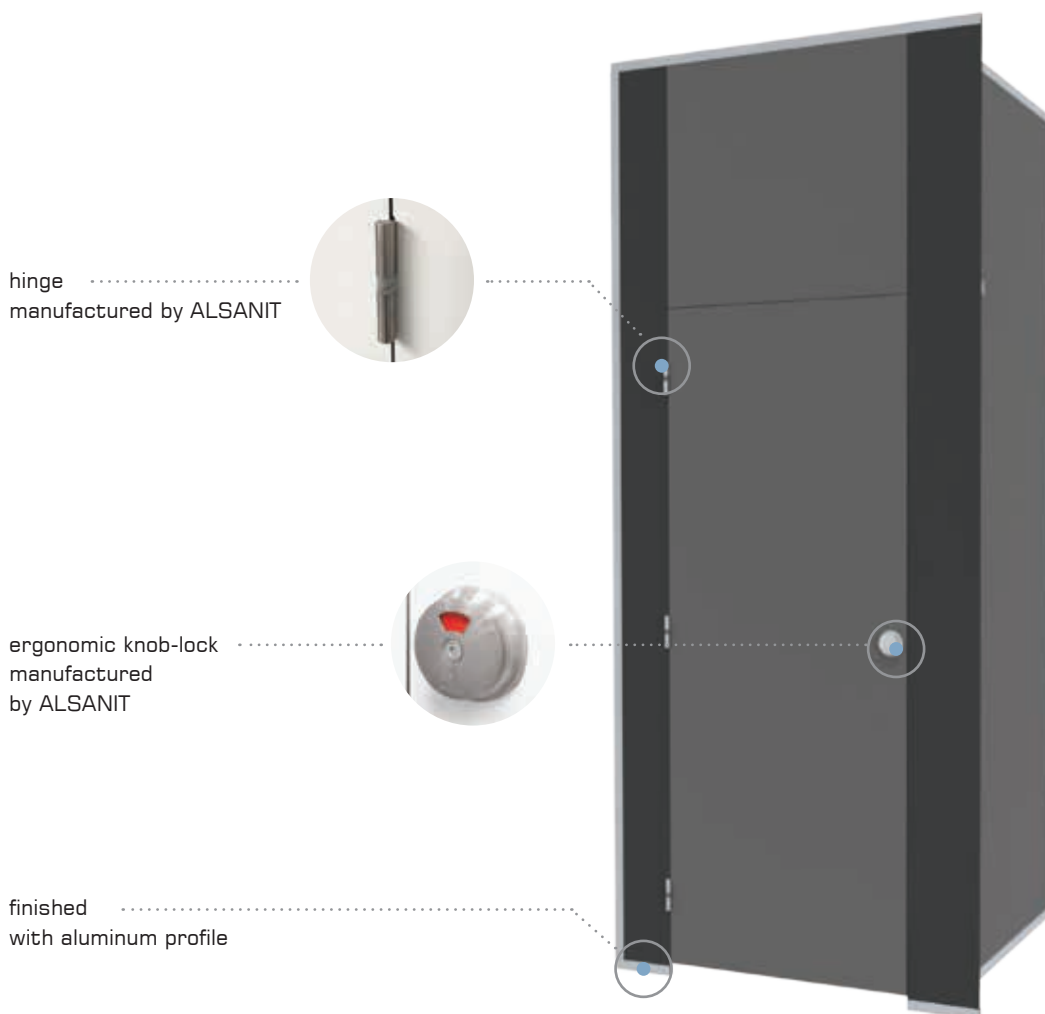

available
colors

[page 173](#) →



ALTUS construction details

Construction details:

Hinges

- tested durability: 200,000 open/close cycles
- typically for ALSANIT, mounted to narrow edges of panels
- made of brushed steel with a polyamide insert
- gravity self-closing
- minimalist appearance
- optionally - hinges for internal doors not visible from the outside

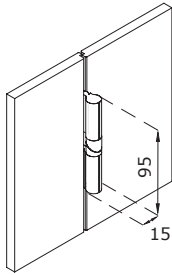

Knob-locks

- elegant, ergonomic and highly durable
- emergency opening capability
- universal for left/right doors
- bolt rotation angle of 360°
- „click“ every 90°
- easy to use, including for individuals with disabilities
- white-red occupancy indicator

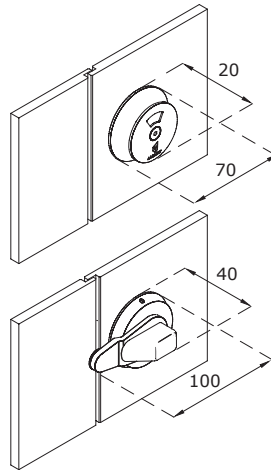

Support-legs (Optionally)

- made of brushed steel
- ensure easy leveling of partitions
- for 10-18 mm boards mounted to the side of the board, for 28 mm and thicker boards screwed into the core
- adjustment range +/- 20 mm
- rosette mounted on two dowels, covered with a plate

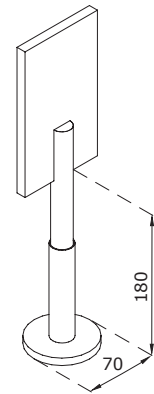

Types of panels available for the system:

MFC

Laminated chipboard

18 mm

28 mm

MFC is compressed under high temperature and pressure using binding agents with wood chips. The top layer is a decorative melamine coating.

- edges are finished with durable edging using HOT-AIR technology (glueless)
- suitable for rooms with normal humidity

Fire classification: Ds1d0



A solution for door frame for MFC boards



Rear-mounted beam



Wall and partition mounting



Optionally Support leg mounted frontally for 18 mm boards



Optionally Support leg screwed into the core for 28 mm boards

HPL

High pressure laminate

10 mm

12 mm

HPL (High Pressure Laminate) - cellulose fibers saturated with resin and compressed under high pressure. The material is 100% waterproof and its properties are consistent throughout the entire board cross-section.

- milled edges-black core of the board is visible
- for rooms with high humidity

Fire classification: Cs2d0 - 10 mm,
Bs1d0 - 12 mm (option)



A solution for door frame for HPL boards



Rear-mounted beam



Wall and partition mounting



Optionally Support leg mounted frontally

SP

Sandwich panels

36 mm

Panels with a total thickness of 36 mm - feature an aluminum frame filled with foamed polystyrene, 28 mm thick, with outer layers consisting of 4 mm HPL.

- excellent rigidity and aesthetics
- ideal for full-height installations
- provide the best soundproofing

Fire classification: Es1d0



A solution for door frame for SP boards



Rear-mounted beam



Concealed mounting for walls and partitions



Possibility of using a handle



Optionally Support leg screwed into the core



VITRAL perfectly fits into the trends of 21st-century architecture, where glass plays a key role.

Fittings refined in every detail complement the prestigious appearance.

[table of content](#)

[← back](#)

[contact](#)



VITRAL

VITRAL

VITRAL cubicles made of glass

Available in:

GLASS - Tempered glass

Optionally - partitions made of HPL

Description:

VITRAL cabins are perfectly suited for exclusive interiors, providing an exceptional visual effect. They are made of double-layered, tempered glass, which is further laminated, allowing for color customization. The tempering process ensures aesthetics and safety, as the doors become hard and resistant to damage.

We understand that the devil is in the details, so all metal elements of cabins are precisely manufactured on our CNC machines. As a result, VITRAL ca-

bins are characterized not only by high aesthetics but also by excellent quality of workmanship.

It is worth noting that preparing the rooms for the installation of these cabins is crucial to achieve the best results. We recommend early contact and utilizing the support of the ALSANIT team during the planning and implementation stages. Glass enclosures require special attention to ensure an impressive end result.



only Torx screws are used



doors opening outward or inward



hinges with gravity self-closing



very high durability



taylor made to individual dimensions



The most prestigious solutions



Aluminum fittings



Fittings developed by ALSANIT are manufactured in Poland at the company headquarters



Production on CNC machines ensures precision and short lead times

Standard dimensions

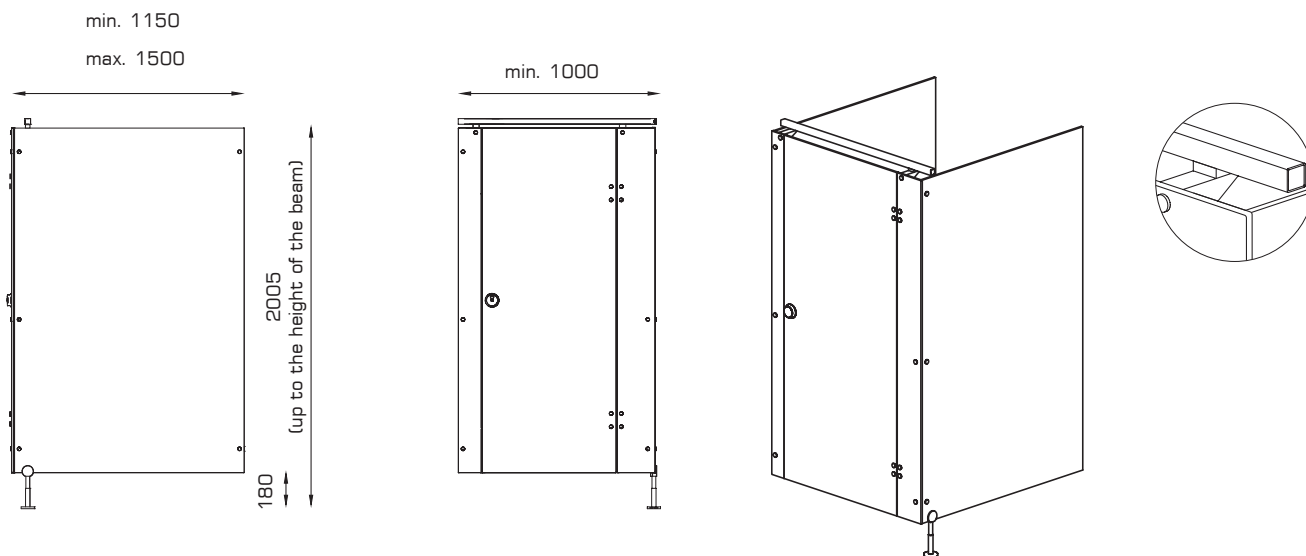

Standard equipment

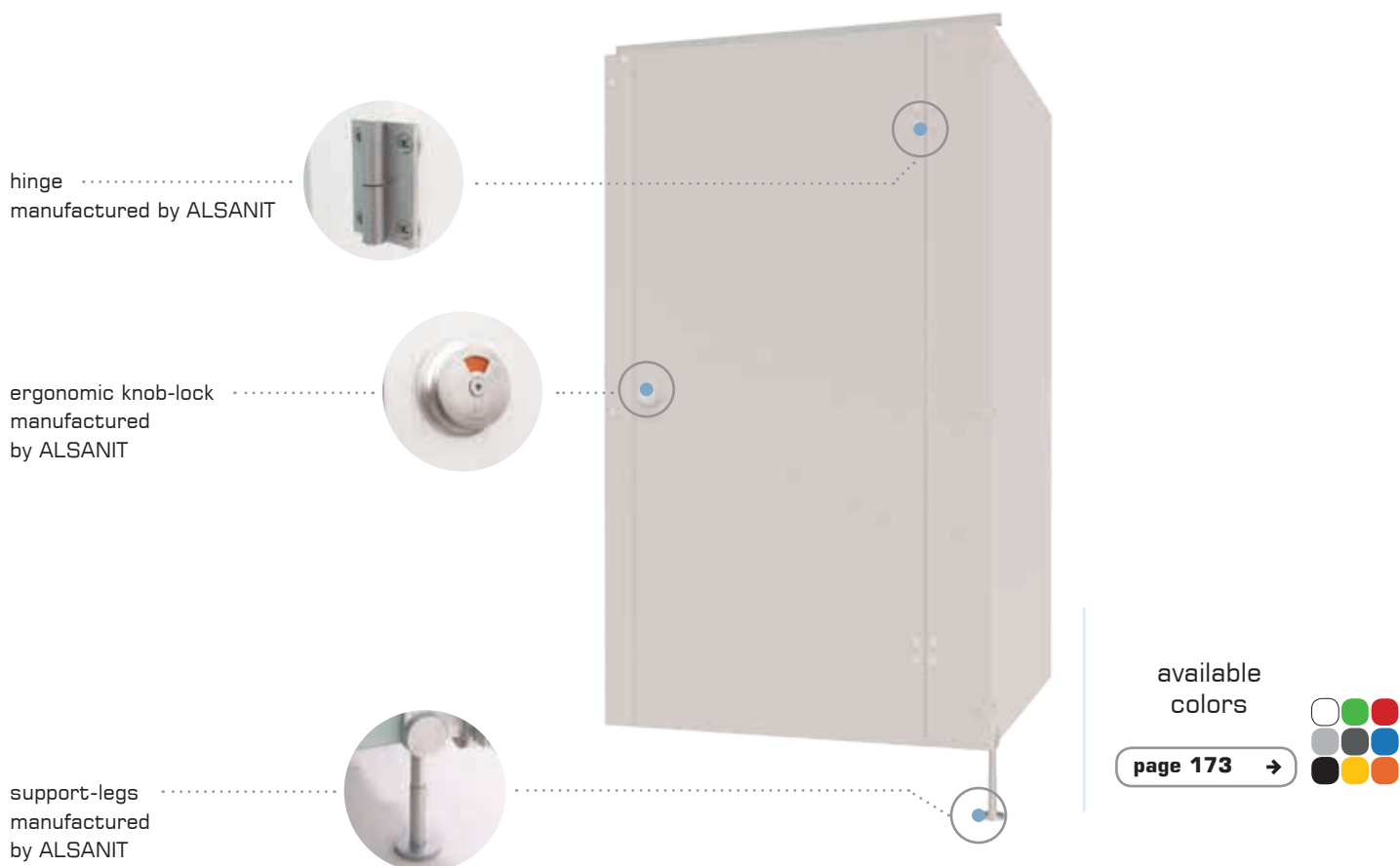

VITRAL construction details

Construction details:

Hinges

- front / rear mounted
- gravity self-closing
- durability: 200,000 open/closed cycles
- minimalist appearance

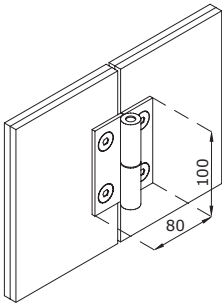

Knob-locks

- elegant, ergonomic and highly durable
- emergency opening capability
- universal for left/right doors
- bolt rotation angle of 360°
- „click” every 90°
- easy to use, including for individuals with disabilities
- white-red occupancy indicator

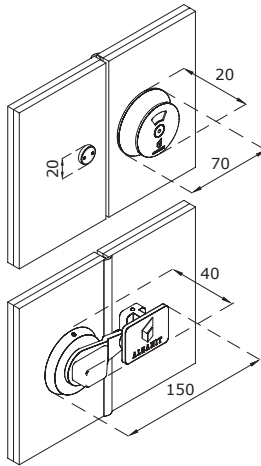

Support-legs

- effect of „hanging” cabins
- recessed 15 cm into the cabin
- ensure easy leveling of partitions
- adjustment range +/- 20 mm to the floor
- rosette mounted on two dowels, covered with a plate

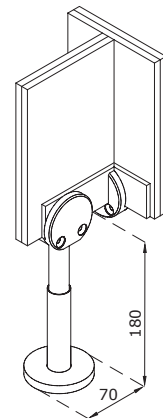

Panels available for the system:

GLASS

Tempered glass

10 mm

12 mm

Tempered glass available in a wide range of RAL colors. To ensure the highest quality of cabins, we use laminated glass. Each panel is constructed with two sheets.

- milled edges
- suitable for rooms with normal and high humidity
- possibility of custom graphics



VITRAL - a unique system for exceptional interiors

ALSANIT has the necessary expertise and machinery to offer such sophisticated solutions as the VITRAL system.

All metal fittings of the cabins are manufactured on our CNC machines. This ensures that VITRAL cabins have a unique character and are meticulously crafted in every aspect.



A solution for door frame



Support leg mounted on the partition wall



Rear-mounted beam



Wall and partition mounting with L brackets





URINAL PARTITIONS

By using an aluminum rosette, we achieved an effect of exceptional lightness.

ALSANIT urinal partitions are installed using rosettes, eliminating the need for support legs.

available
colors



page 173 →

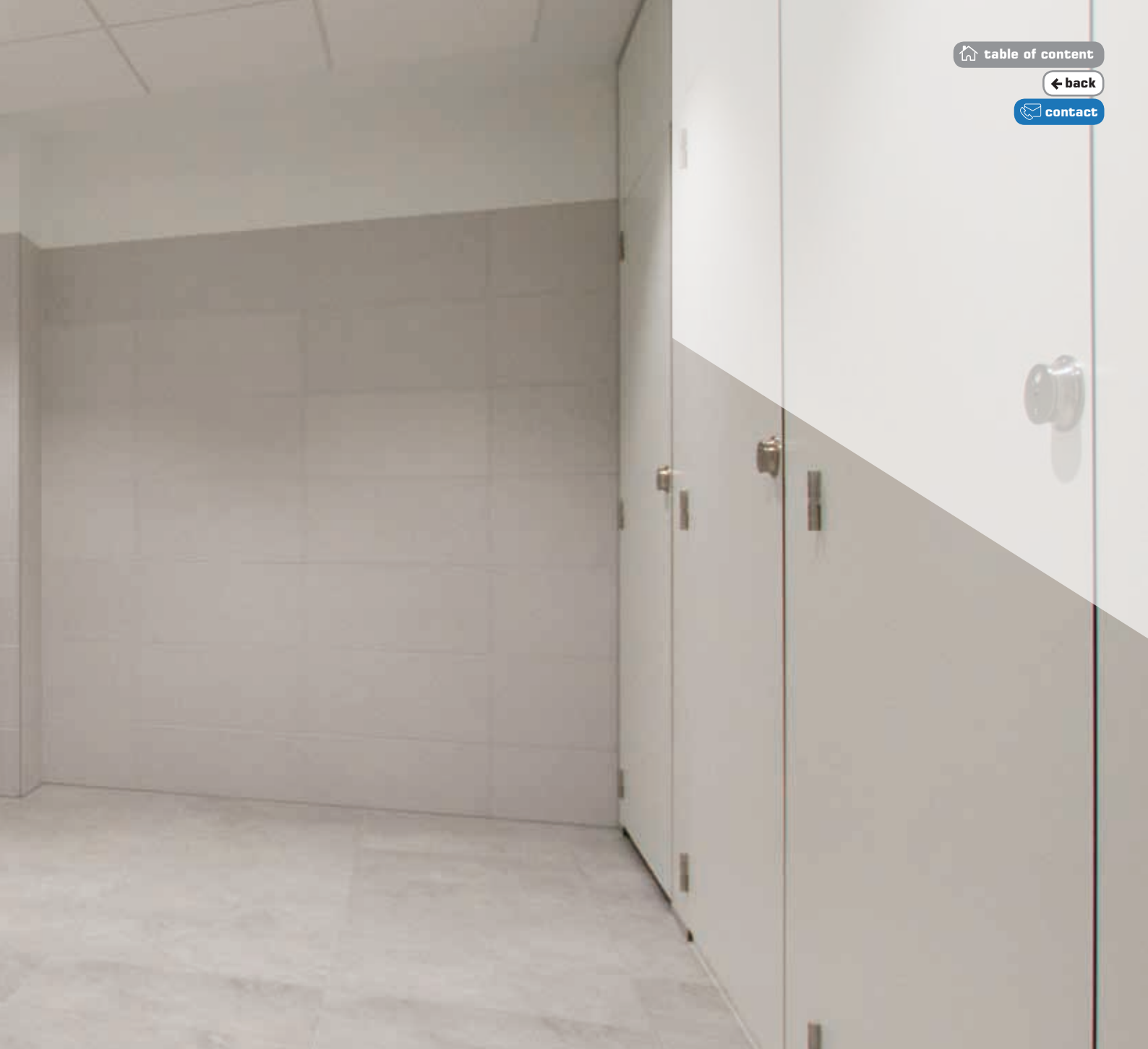

Urinal partitions

- Powder-coated rosette in a color close to RAL 7035
- Easy installation
- Minimalist appearance

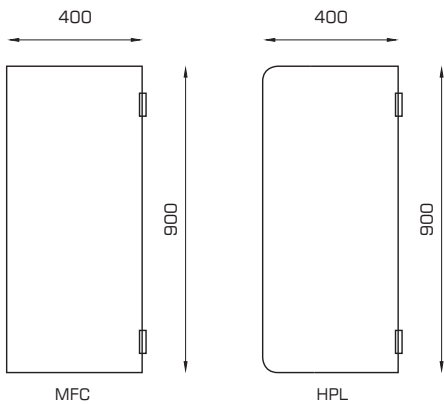

MFC

18 mm

28 mm

HPL

10 mm

12 mm

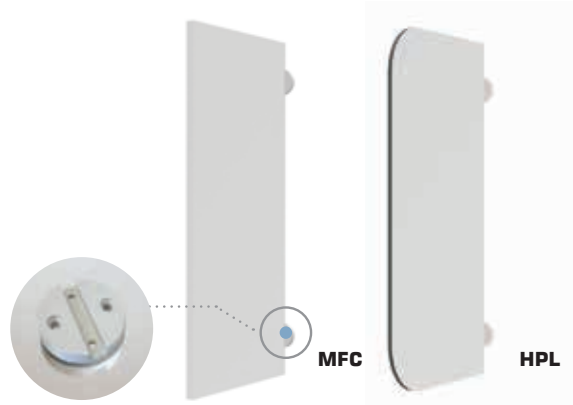

HPL BUILT-INS

HPL panels are waterproof and exceptionally durable, making them increasingly popular in architecture and furniture. We have been working with them for over 20 years.



SHOWERS

Shower cubicles produced by ALSANIT are aesthetic, practical, and durable.

Thanks to the use of durable, and fully waterproof materials, ALSANIT shower cubicles are an investment for many years. Showers are typically made basing on the SOLARI system fittings.

available
colors

page 173 →



„I” partitions

- easy and fast installation
- curtain included

HPL

10 mm

12 mm

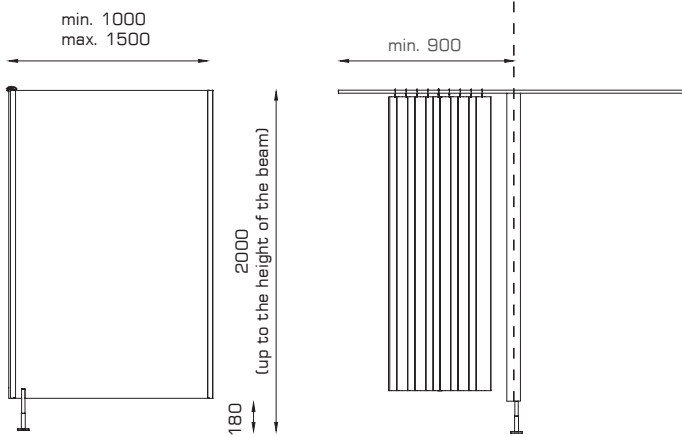
[← back](#)[contact](#)

Showers „T” i „F”

- additional space for storing clothes
- curtain included

HPL

10 mm

12 mm

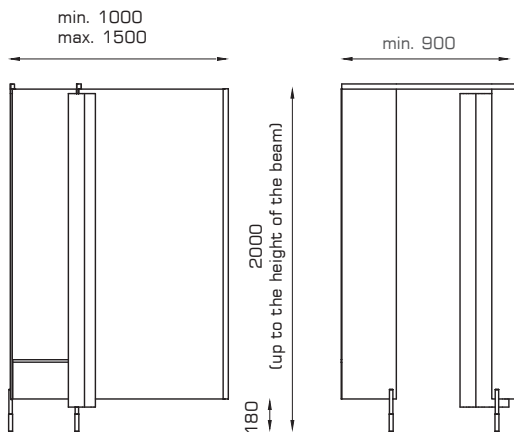

Showers with doors

- doors reinforced with ribs approximately 80 mm wide
- round profile for clothes or towel between the ribs

HPL

10 mm

12 mm

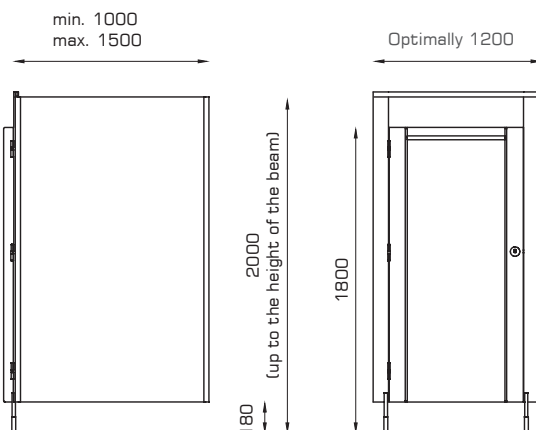



VANITY TOPS

Sink countertops are an important element of restroom furnishings.

Due to the direct exposure to water, they need to be made of durable materials and properly installed.

available
colors

page 173 →





Vanity tops

- preparation for sink installation
- all visible edges routed
- need for panel joining for countertops longer than 2600 mm
- optionally additional mirror frames matching countertops

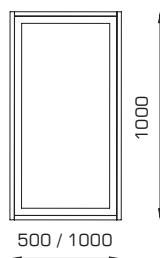
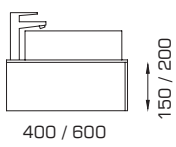
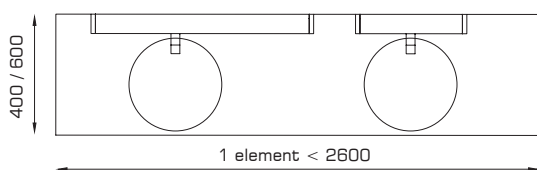

HPL

10 mm

12 mm





TECHNOWALL

Fast mounted and aesthetically pleasing wall claddings designed for large surfaces.

TECHNOWALL is a fully proprietary system of wall claddings with quick access to installations located behind them.

available
colors



page 173 →

TECHNOWALL wall claddings

HPL

10 mm

12 mm

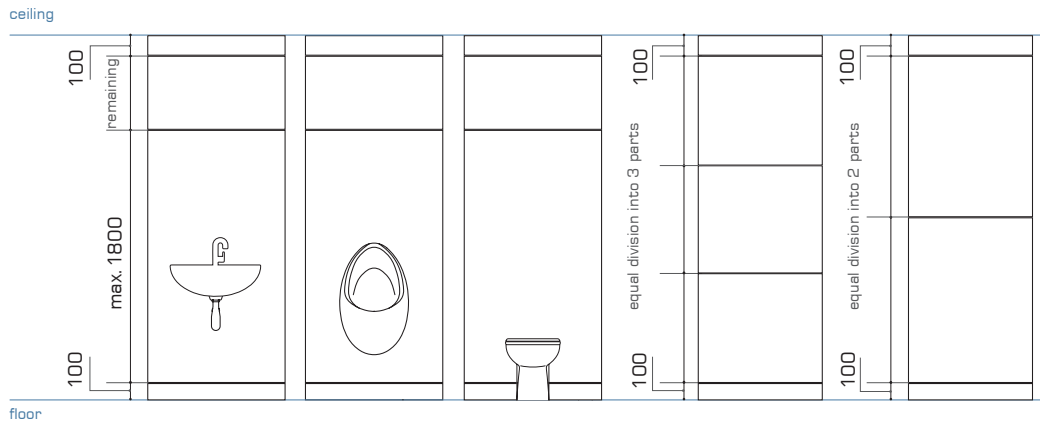

Installation:



1. Level and mount the bottom profile to the floor.

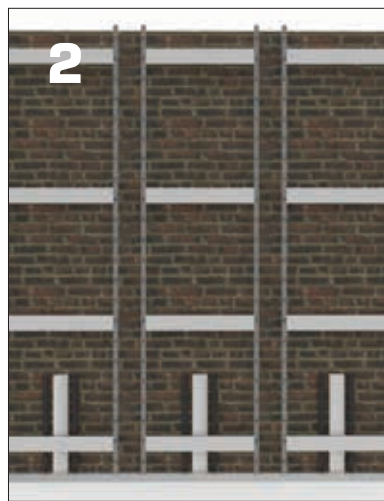

2. Place the steel frames for cladding on the profile, align, and attach them to the masonry wall.



3. Connect the frames with „shadow“ panels. Mount masking panels at the bottom and top.



4. Fit the cladding panels up to the height of the utilities and fixtures. For the cladding where fixtures will be installed, cut openings for the connections/fixtures.

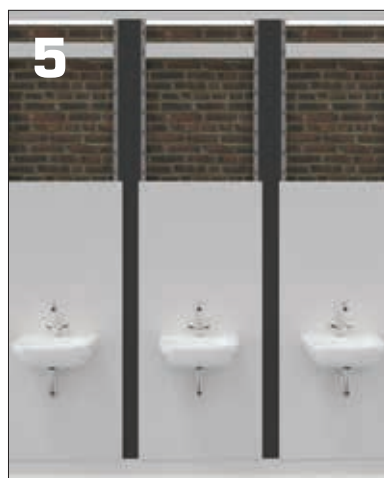

5. Secure and connect the fixtures to the cladding.

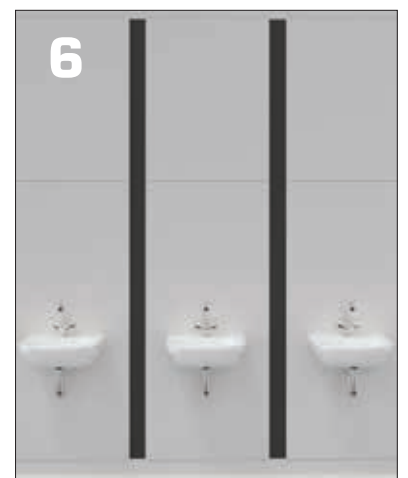

6. Install the remaining cladding.



Together, we create your dream interiors.

With our rich range of materials and decors, we create practically unlimited design and arrangement possibilities.



COLORS



ALSANIT®

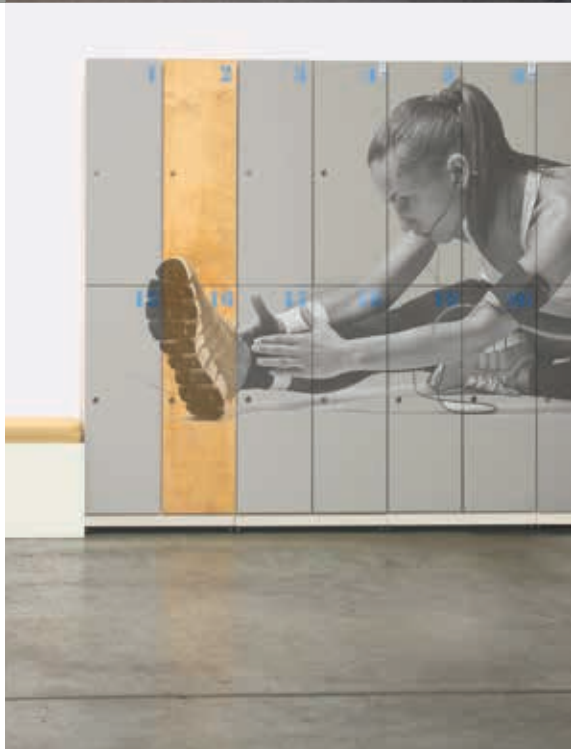

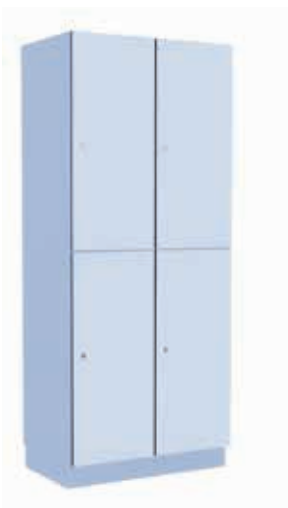

The **STOCK** version - at no extra cost

Take advantage of our extensive stock collection of available HPL, MFC, and GLASS, as well as metal paint, and configure furniture at no extra cost. There are countless configuration possibilities.

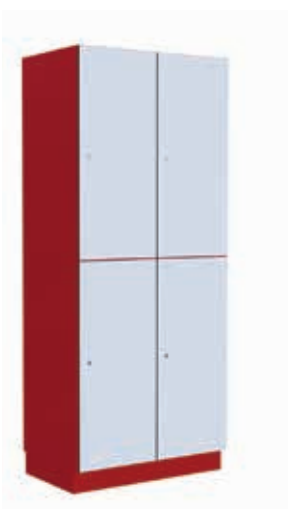

The **EXTENDED** Version - extra charge

If you would like to have the furniture bodies made in colors other than those originally designated for bodies, there is an additional surcharge of +15%.

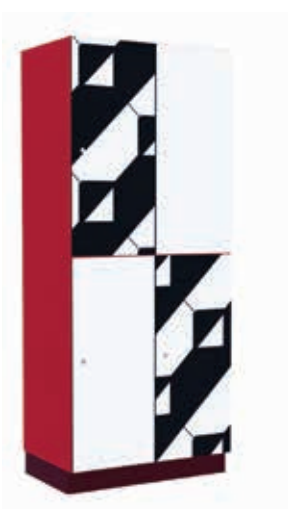

BESPOKE Version - custom color scheme upon individual request

In addition to non-standard board colors, we can also enrich the project with graphics or decals. If you wish for colors not available in our warehouse collection, you can choose any board color, paint, or decor from the available palette, and we will order it for you.

HPL + MFC - available from the ALSANIT board suppliers' collections

PAINT FOR METAL + GLASS - available from the RAL color collection

COLORS stock collection

HPL

LOCKERS

HPL BUILT-INS

CUBICLES

CONTRACT FURNITURE

standard colors of locker bodies
standard colors of Sandwich Panels



colors available only for lockers and furniture

METAL

LOCKERS

standard colors of locker bodies



* sample colors

MFC

LOCKERS

CUBICLES

CONTRACT FURNITURE



the color range is also available in the HIGH GLOSS version

GLASS

LOCKERS

CUBICLES



* sample colors

CONTACT



Alsanit Sp. z o.o.
ul. Wieleńska 2, 64-980 Trzcianka, POLSKA

+48 67 253 23 60
export@alsanit.eu
www.alsanit.eu

WE OPERATE AND DELIVER WORLDWIDE. WE LOOK FOR BUSINESS PARTNERS.

CONTACT OUR SALES DEPARTMENT FOR COOPERATION DETAILS.

EUROPE



northern reg.
north@alsanit.eu
+48 453 039 919



southern reg.
south@alsanit.eu
+48 453 039 919



western reg.
west@alsanit.eu
+48 662 138 120

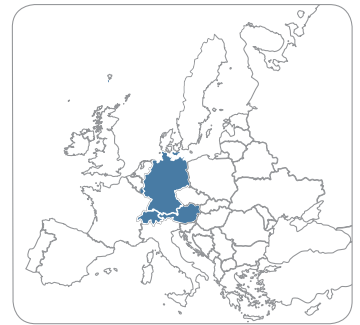

central reg.
dach@alsanit.eu
+48 600 985 436

DOMESTIC

main contact
alsanit@alsanit.pl
+48 67 253 23 60



eastern reg.
wschod@alsanit.pl
+48 728 881 841

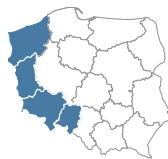

western reg.
zachod@alsanit.pl
+48 533 501 130



central reg.
centrum@alsanit.pl
+48 728 952 837

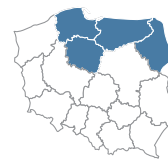

northern reg.
polnoc@alsanit.pl
+48 530 995 230



southern reg.
poludnie@alsanit.pl
+48 662 049 441



ALSANIT®

export@alsanit.eu
www.alsanit.eu