



ALSANIT®

PERSEI

PERSEI



CE

PERSEI cubicles made of hpl / mfc / sp

Available in:

- MFC** - Laminated chipboard
- HPL** - High Pressure Laminate
- SP** - Sandwich panels

Complementary products

page 6 →

Description:

Brushed steel has become a popular element in modern architecture. The PERSEI system, specially designed by ALSANIT's engineers, features ergonomic and elegant fittings with a brushed steel finish.

This versatile system is compatible with various types of panels. Aluminum profiles with a delicate design securely hold the structure together, providing rigidity while maintaining a sense of exceptional lightness. The PERSEI system is an excellent choice for projects where elegance and functionality go hand in hand. The

reinforcing headrail is typically concealed behind the cabin doors, adding elegance and aesthetics to the fronts.

The system can be installed independently according to the provided instructions or with the assistance of an authorized ALSANIT installation team, ensuring convenience and confidence in proper assembly.

- only Torx screws are used
- doors opening outward or inward
- hinges with gravity self-closing
- very high durability
- tailor made to individual dimensions



CE certificate valid throughout the European Union



Fittings with a brushed steel finish



Fittings developed by ALSANIT are manufactured in Poland at the company headquarters



Production on CNC machines ensures precision and short lead times

Standard dimensions

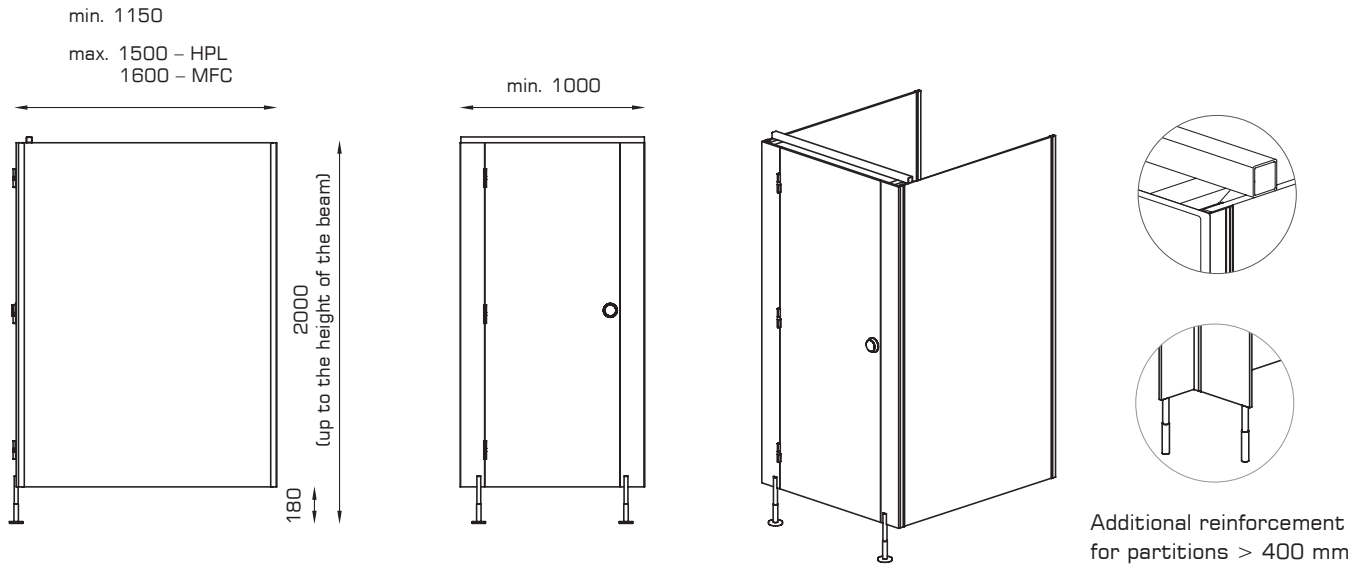

Standard equipment

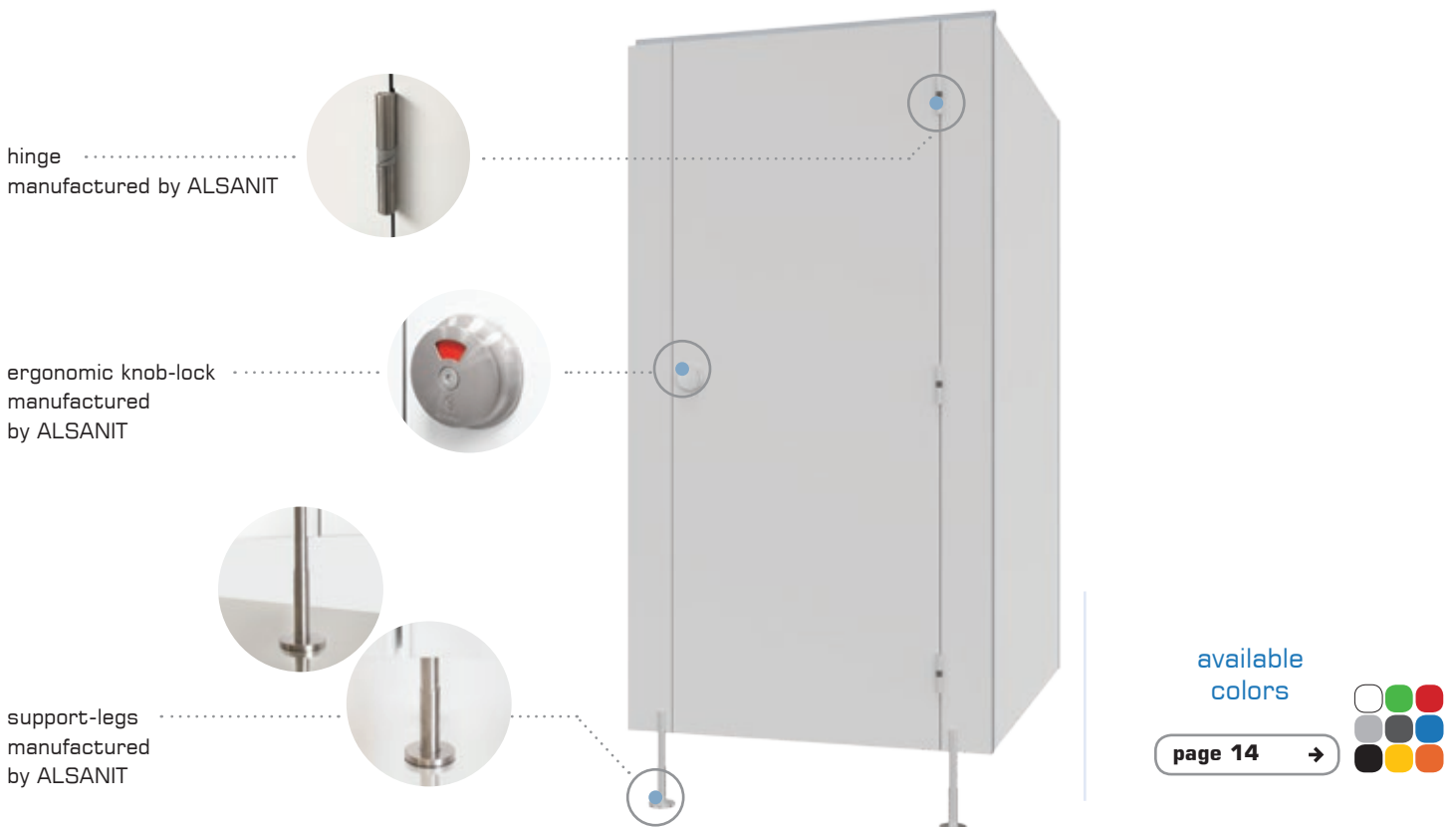

PERSEI construction details

Construction details:

Hinges

- tested durability: 200,000 open/close cycles
- typically for ALSANIT, mounted to narrow edges of panels
- made of brushed steel with a polyamide insert
- gravity self-closing
- minimalist appearance
- optionally - hinges for internal doors not visible from the outside

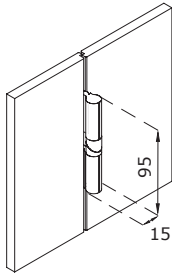

Knob-locks

- elegant, ergonomic and highly durable
- emergency opening capability
- universal for left/right doors
- bolt rotation angle of 360°
- „click” every 90°
- easy to use, including for individuals with disabilities
- white-red occupancy indicator

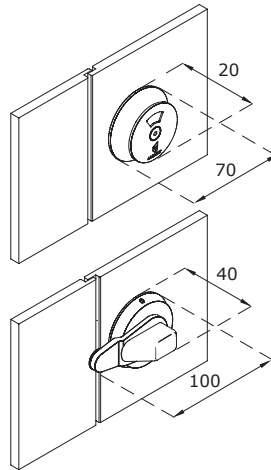

Support-legs

- made of brushed steel
- ensure easy leveling of partitions
- for 10-18 mm boards mounted to the side of the board, for 28 mm and thicker boards screwed into the core
- adjustment range +/- 20 mm
- rosette mounted on two dowels, covered with a plate

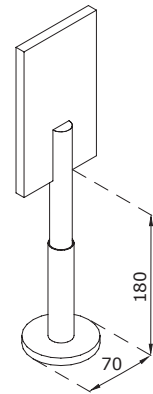

Types of panels available for the system:

MFC

Laminated chipboard

18 mm

28 mm

MFC is compressed under high temperature and pressure using binding agents with wood chips. The top layer is a decorative melamine coating.

- edges are finished with durable edging using HOT-AIR technology (glueless)
- suitable for rooms with normal humidity

Fire classification: Ds1d0



 A solution for door frame for MFC boards

 Support leg mounted frontally for 18 mm boards

 Support leg screwed into the core for 28 mm boards

 Rear-mounted beam

 Wall and partition mounting

HPL

High pressure laminate

10 mm

12 mm

HPL (High Pressure Laminate) - cellulose fibers saturated with resin and compressed under high pressure. The material is 100% waterproof and its properties are consistent throughout the entire board cross-section.

- milled edges-black core of the board is visible
- for rooms with high humidity

Fire classification: Cs2d0 - 10 mm, Bs1d0 - 12 mm (option)



 A solution for door frame for HPL boards

 Support leg mounted frontally

 Rear-mounted beam

 Wall and partition mounting

SP

Sandwich panels

36 mm

Panels with a total thickness of 36 mm - feature an aluminum frame filled with foamed polystyrene, 28 mm thick, with outer layers consisting of 4 mm HPL.

- excellent rigidity and aesthetics
- ideal for full-height installations
- provide the best soundproofing

Fire classification: Es1d0



 A solution for door frame for SP boards

 Support leg screwed into the core

 Rear-mounted beam

 Possibility of using a handle

 Concealed mounting for walls and partitions



URINAL PARTITIONS

By using an aluminum rosette, we achieved an effect of exceptional lightness.

ALSANIT urinal partitions are installed using rosettes, eliminating the need for support legs.

available
colors



page 14 →



Urinal partitions

- Powder-coated rosette in a color close to RAL 7035
- Easy installation
- Minimalist appearance

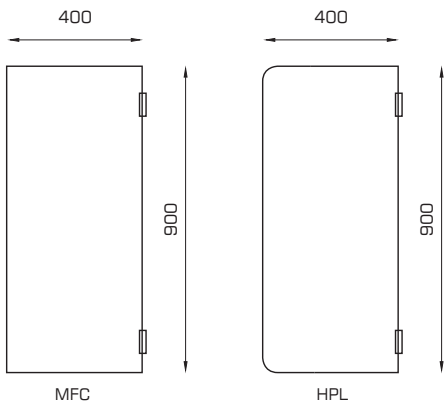

MFC

- 18 mm
- 28 mm

HPL

- 10 mm
- 12 mm

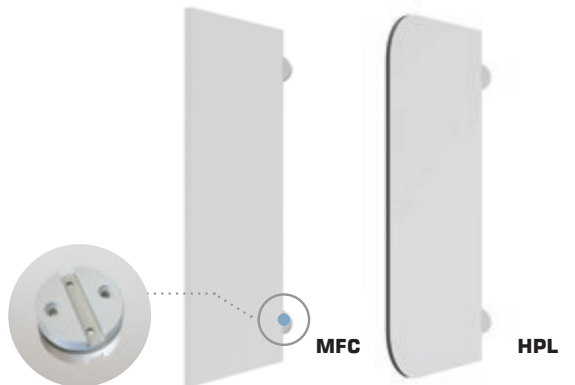



VANITY TOPS

Sink countertops are an important element of restroom furnishings.

Due to the direct exposure to water, they need to be made of durable materials and properly installed.

available
colors

page 14 →





Vanity tops

- preparation for sink installation
- all visible edges routed
- need for panel joining for countertops longer than 2600 mm
- optionally additional mirror frames matching countertops

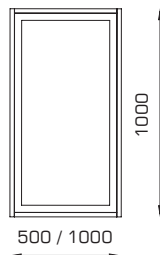
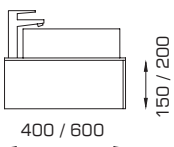
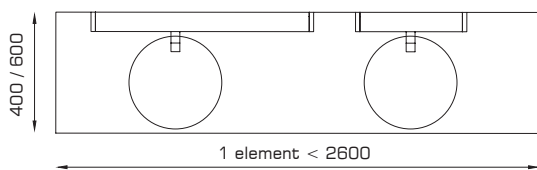

HPL

10 mm

12 mm





SHOWERS

Shower cubicles produced by ALSANIT are aesthetic, practical, and durable.

Thanks to the use of durable, and fully waterproof materials, ALSANIT shower cubicles are an investment for many years. Showers are typically made basing on the SOLARI system fittings.

available
colors

page 14 →



„I” partitions

- easy and fast installation
- curtain included

HPL

10 mm

12 mm

← back

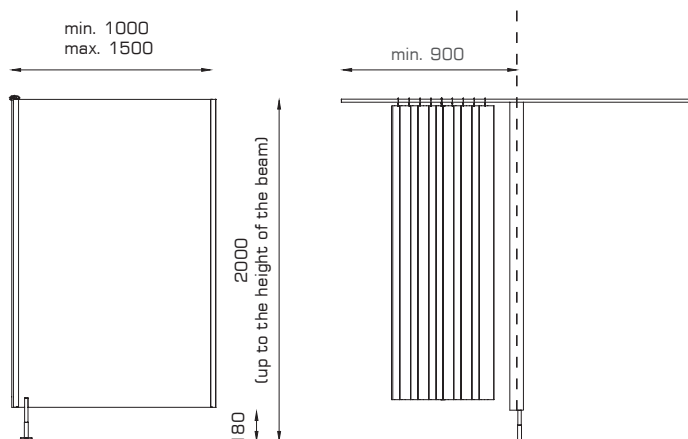

Showers „T” i „F”

- additional space for storing clothes
- curtain included

HPL

10 mm

12 mm

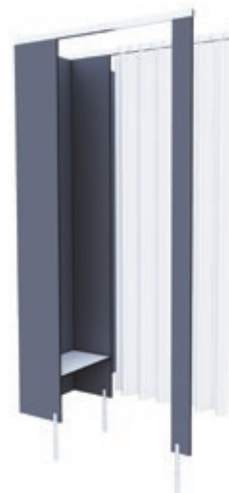
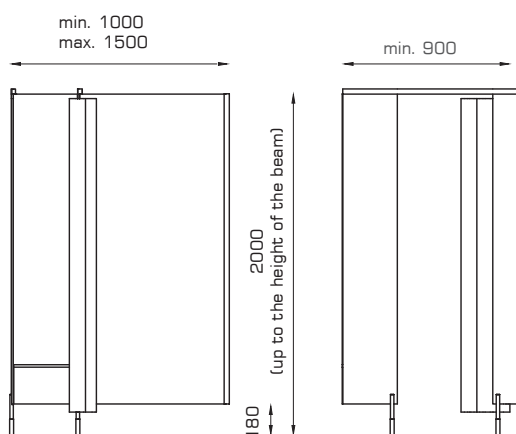

Showers with doors

- doors reinforced with ribs approximately 80 mm wide
- round profile for clothes or towel between the ribs

HPL

10 mm

12 mm

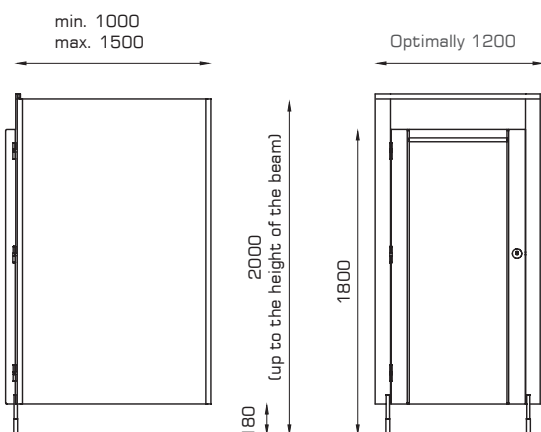



TECHNOWALL

Fast mounted and aesthetically pleasing wall claddings designed for large surfaces.

TECHNOWALL is a fully proprietary system of wall claddings with quick access to installations located behind them.

available
colors



page 14 →

HPL

10 mm

12 mm

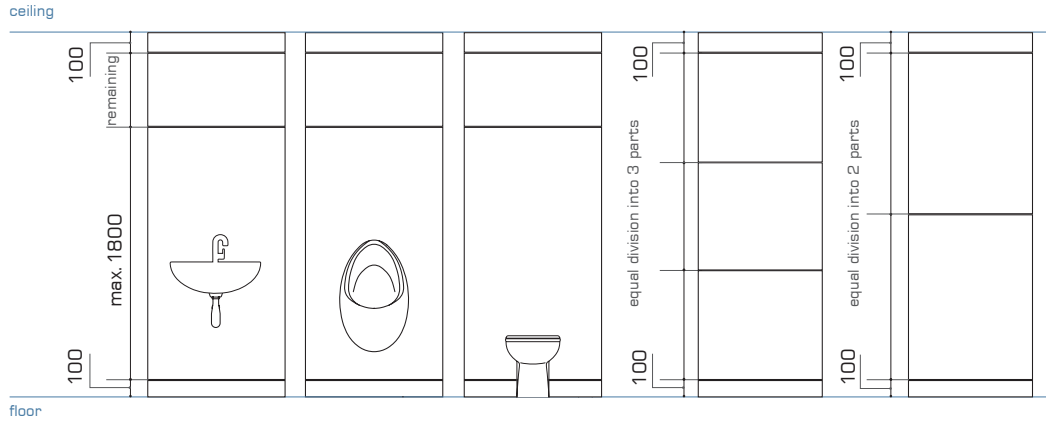

Installation:

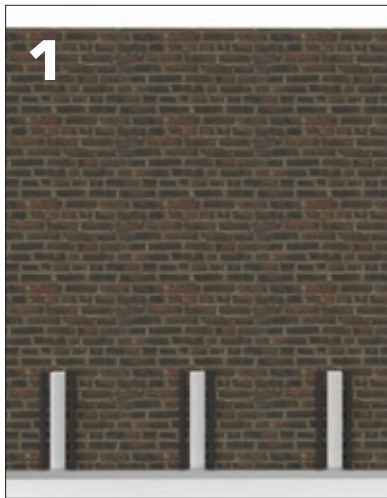

1. Level and mount the bottom profile to the floor.

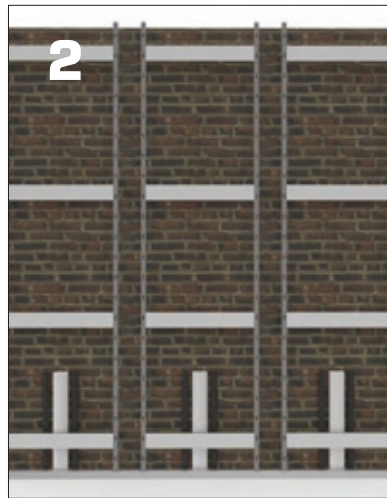

2. Place the steel frames for cladding on the profile, align, and attach them to the masonry wall.

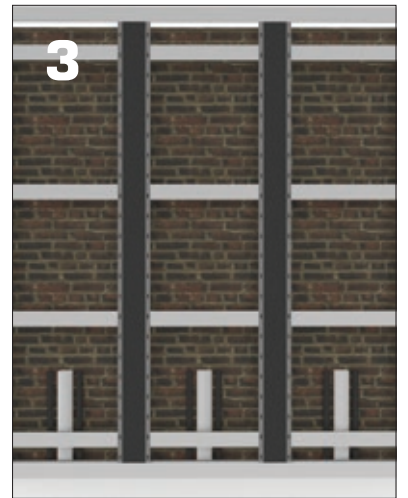

3. Connect the frames with „shadow” panels. Mount masking panels at the bottom and top.

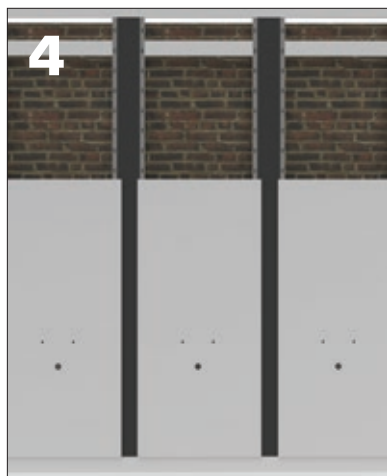

4. Fit the cladding panels up to the height of the utilities and fixtures. For the cladding where fixtures will be installed, cut openings for the connections/fixtures.

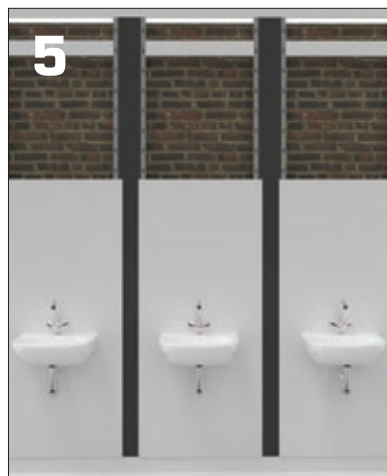

5. Secure and connect the fixtures to the cladding.



6. Install the remaining cladding.

COLORS stock collection

HPL

LOCKERS

HPL BUILT-INS

CUBICLES

CONTRACT FURNITURE

standard colors of locker bodies
standard colors of Sandwich Panels

4,10,12 mm
CLASSIC WHITE
~ RAL 9016

4,10,12 mm
PERFECT GREY
~ RAL 7035

4,10,12 mm
SILESIA N GREY
~ RAL 7043

10 mm
JUICY LEMON
~ RAL 1016

10 mm
JUICY ORANGE
~ RAL 2011

10 mm
RED DELUXE
~ RAL 3020

10 mm
FRESH GREEN
~ RAL 6038

10 mm
BLUE BAY
~ RAL 5005

10,12 mm
SHADOW GREY
~ RAL 7042

10 mm
CLASSIC BLACK
~ RAL 9005

10 mm
SPICE ORANGE
~ RAL 2008

10 mm
FOREST GREEN
~ RAL 6018

10 mm
EMERALD LAGUNA
~ RAL 5018

10 mm
LION WOOD
HORIZONTAL

colors available only for lockers and furniture

METAL

LOCKERS

standard colors of locker bodies

PURE WHITE
~ RAL 9010

PERFECT GREY
~ RAL 7035

COAL GREY
~ RAL 7016

JUICY ORANGE
~ RAL 2004

RED HOT
~ RAL 3000

FOREST GREEN
~ RAL 6018

OCEAN BLUE
~ RAL 5010

MARINA BLUE
~ RAL 5015

CLASSIC BLACK
~ RAL 9005

* sample colors

MFC

LOCKERS

CUBICLES

CONTRACT FURNITURE



the color range is also available in the **HIGH GLOSS** version

GLASS

LOCKERS

CUBICLES



* sample colors



20+

20 years of experience

25+

sales to over 25 countries

2600+

2600 projects annually

8000+

sqm of ALSANIT's hall space

40000+

doors produced annually

Beauty, prestige, precision - these are the key features of the PERSEI system.

We have achieved them through the highest quality fittings specially designed by ALSANIT's engineers.



ALSANIT®

Alsanit Sp. z o.o.
ul. Wieleńska 2, 64-980 Trzcianka, POLSKA

+48 67 253 23 60
export@alsanit.eu
www.alsanit.eu