

ALSANIT®

VELA

VELA



AC 171

VELA metal body, metal / hpl / mfc doors

Body:

METAL - Powder-coated galvanized steel

Doors:

METAL - Powder-coated galvanized steel

HPL - High pressure laminate

MFC - Laminated chipboard

Description:

In the competitive market of metal lockers, many companies promote their products primarily based on price. However, the lowest price does not necessarily align with quality.

VELA lockers are available at a competitive price, but our priority in their design was to ensure quality and durability better than that of other manufacturers. We aimed to guarantee long-lasting, trouble-free use, which in the long run is more cost-effective than purchasing the cheapest products that quickly de-

teriorate.

The bodies are always made of galvanized steel, with adjustable legs and durable accessories like those from our higher-end locker models. The ventilation system helps to avoid unpleasant odors and moisture buildup inside the locker, which is particularly important in schools and changing rooms where shoes and clothing are stored.

VELA lockers meet all legal requirements and are recommended with full confidence.

 Prepared for
Smart Locker

page 17 →

 fully assembled product

 employee lockers - standard vertical partition

 reinforced metal doors

 easy to clean



Quality confirmed by certificates



Budget solutions



Even gaps between the doors



Certificate of conformity number: PN-EN 16121+A1:2017-11



Central access

page 8 →

Standard dimensions

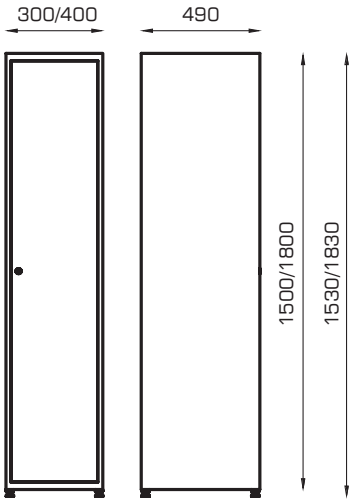

Base options

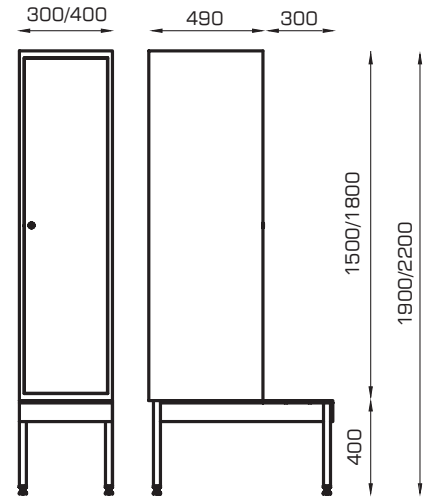
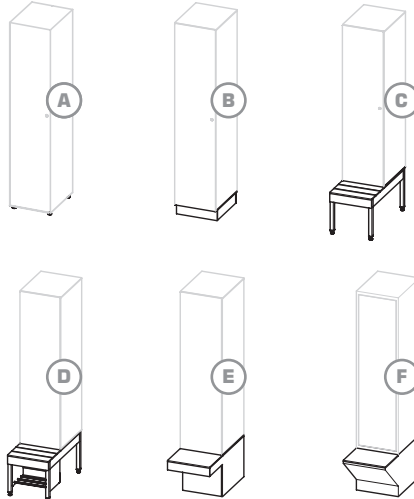

Standard equipment



available additional options

page 10 →

available lock options

page 16 →

available colors

page 20 →



VELA metal body, metal / hpl / mfc doors



Single-level lockers

Doors available in:

METAL MFC HPL

STANDARD VERSION

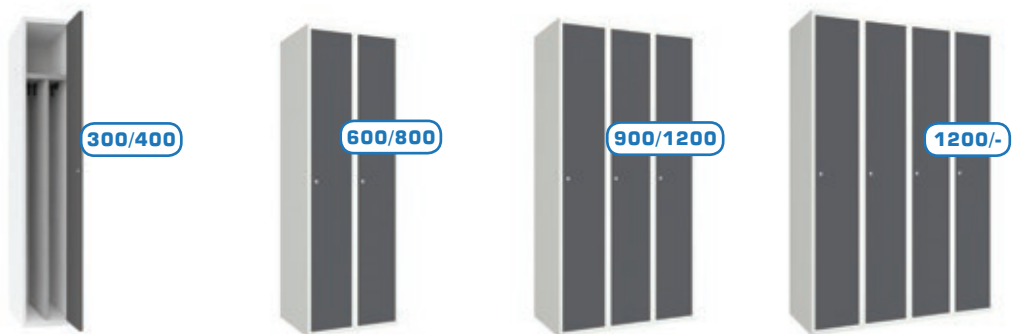

DIMENSIONS	PRODUCT CODE	VD-15311-11	VD-15411-11	VD-15321-11	VD-15421-11	VD-15331-11	VD-15431-11	VD-15341-11	-
	HEIGHT	1500	1500	1500	1500	1500	1500	1500	-
	PRODUCT CODE	VD-18311-11	VD-18411-11	VD-18321-11	VD-18421-11	VD-18331-11	VD-18431-11	VD-18341-11	-
	HEIGHT	1800	1800	1800	1800	1800	1800	1800	-
	OVERALL WIDTH	300	400	600	800	900	1200	1200	-
	COLUMN WIDTH	1X300	1X400	2X300	2X400	3X300	3X400	4X300	-
	DEPTH	490	490	490	490	490	490	490	-
EQUIPMENT	LEGS HEIGHT 30	✓	✓	✓	✓	✓	✓	✓	-
	SHELF + PRZEGRODA	✓	✓	✓	✓	✓	✓	✓	-
	BAR WITH HOOKS	✓	✓	✓	✓	✓	✓	✓	-
	CLOTHING HOOK	✓	✓	✓	✓	✓	✓	✓	-
	KEY LOCK	✓	✓	✓	✓	✓	✓	✓	-
	PADLOCK LOCK	✓	✓	✓	✓	✓	✓	✓	-

+	TYPES OF LOCKS	AVAILABLE TYPES OF LOCKS: PAGE 16
	ADDITIONAL OPTIONS	AVAILABLE ADDITIONAL OPTIONS: PAGE 10
	COLOR OPTIONS	AVAILABLE COLOR OPTIONS: PAGE 20



Two-level lockers

Doors available in:

- METAL MFC HPL

STANDARD VERSION

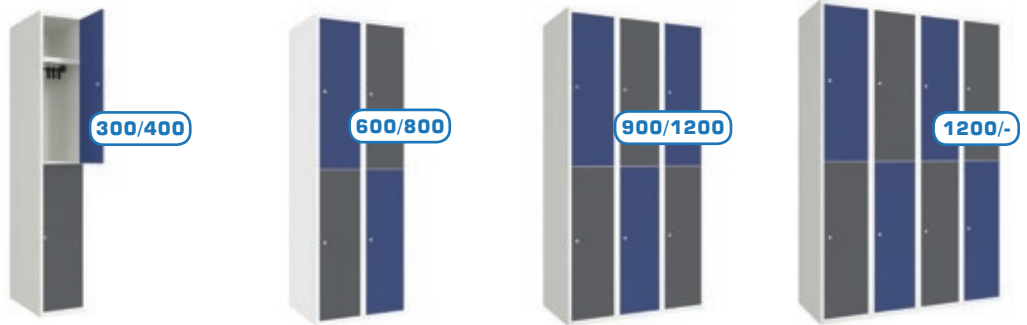

DIMENSIONS	PRODUCT CODE	VD-15312-01	VD-15412-01	VD-15322-01	VD-15422-01	VD-15332-01	VD-15432-01	VD-15342-01	-
	HEIGHT	1500	1500	1500	1500	1500	1500	1500	-
	PRODUCT CODE	VD-18312-01	VD-18412-01	VD-18322-01	VD-18422-01	VD-18332-01	VD-18432-01	VD-18342-01	-
	HEIGHT	1800	1800	1800	1800	1800	1800	1800	-
	OVERALL WIDTH	300	400	600	800	900	1200	1200	-
	COLUMN WIDTH	1X300	1X400	2X300	2X400	3X300	3X400	4X300	-
	DEPTH	490	490	490	490	490	490	490	-
EQUIPMENT	LEGS HEIGHT 30	✓	✓	✓	✓	✓	✓	✓	-
	SHELF	✓	✓	✓	✓	✓	✓	✓	-
	BAR WITH HOOKS	✓	✓	✓	✓	✓	✓	✓	-
	CLOTHING HOOK	✓	✓	✓	✓	✓	✓	✓	-
	KEY LOCK	✓	✓	✓	✓	✓	✓	✓	-
	PADLOCK LOCK	✓	✓	✓	✓	✓	✓	✓	-

TYPES OF LOCKS

AVAILABLE TYPES OF LOCKS: PAGE 16

ADDITIONAL OPTIONS

AVAILABLE ADDITIONAL OPTIONS: PAGE 10

COLOR OPTIONS

AVAILABLE COLOR OPTIONS: PAGE 20

VELA metal body, metal / hpl / mfc doors

Three-level lockers

Doors available in:

METAL MFC HPL

STANDARD VERSION

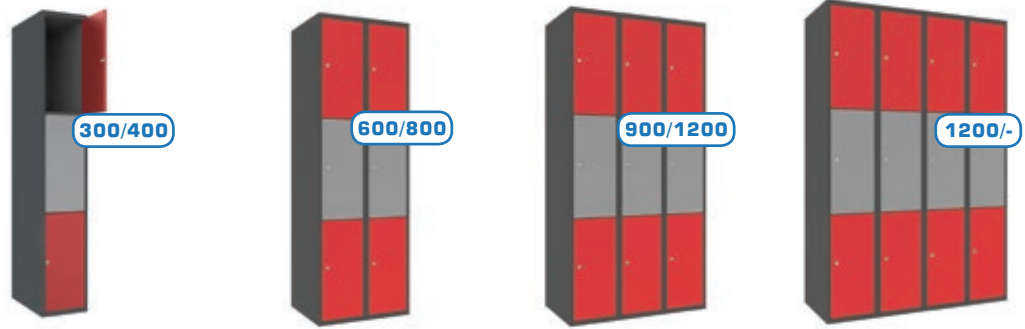

DIMENSIONS	PRODUCT CODE	VD-15313-00	VD-15413-00	VD-15323-00	VD-15423-00	VD-15333-00	VD-15433-00	VD-15343-00	-
	HEIGHT	1500	1500	1500	1500	1500	1500	1500	-
	PRODUCT CODE	VD-18313-00	VD-18413-00	VD-18323-00	VD-18423-00	VD-18333-00	VD-18433-00	VD-18343-00	-
	HEIGHT	1800	1800	1800	1800	1800	1800	1800	-
	OVERALL WIDTH	300	400	600	800	900	1200	1200	-
	COLUMN WIDTH	1X300	1X400	2X300	2X400	3X300	3X400	4X300	-
DEPTH	490	490	490	490	490	490	490	-	
EQUIPMENT	LEGS HEIGHT 30	✓	✓	✓	✓	✓	✓	✓	-
	SHELF	-	-	-	-	-	-	-	-
	BAR WITH HOOKS	-	-	-	-	-	-	-	-
	CLOTHING HOOK	✓	✓	✓	✓	✓	✓	✓	-
	KEY LOCK	✓	✓	✓	✓	✓	✓	✓	-
PADLOCK LOCK	✓	✓	✓	✓	✓	✓	✓	-	
+	TYPES OF LOCKS	AVAILABLE TYPES OF LOCKS: PAGE 16							
	ADDITIONAL OPTIONS	AVAILABLE ADDITIONAL OPTIONS: PAGE 10							
	COLOR OPTIONS	AVAILABLE COLOR OPTIONS: PAGE 20							

Five-level lockers

Doors available in:

METAL MFC HPL

STANDARD VERSION

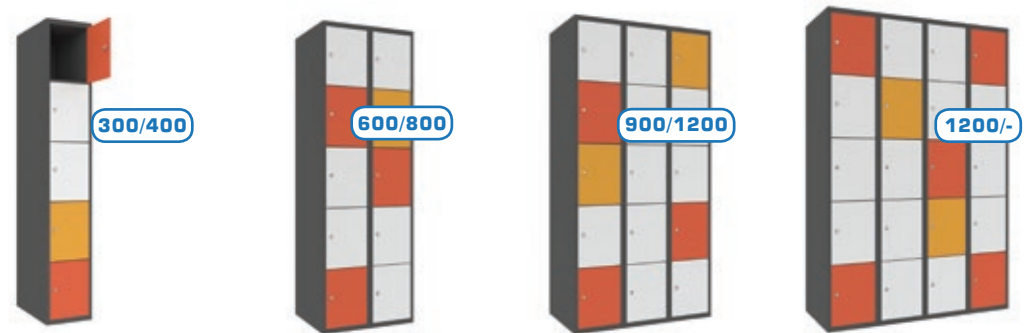

DIMENSIONS	PRODUCT CODE	VD-15315-00	VD-15415-00	VD-15325-00	VD-15425-00	VD-15335-00	VD-15435-00	VD-15345-00	-
	HEIGHT	1500	1500	1500	1500	1500	1500	1500	-
	PRODUCT CODE	VD-18315-00	VD-18415-00	VD-18325-00	VD-18425-00	VD-18335-00	VD-18435-00	VD-18345-00	-
	HEIGHT	1800	1800	1800	1800	1800	1800	1800	-
	OVERALL WIDTH	300	400	600	800	900	1200	1200	-
	COLUMN WIDTH	1X300	1X400	2X300	2X400	3X300	3X400	4X300	-
DEPTH	490	490	490	490	490	490	490	-	
EQUIPMENT	LEGS HEIGHT 30	✓	✓	✓	✓	✓	✓	✓	-
	SHELF	-	-	-	-	-	-	-	-
	BAR WITH HOOKS	-	-	-	-	-	-	-	-
	CLOTHING HOOK	-	-	-	-	-	-	-	-
	KEY LOCK	✓	✓	✓	✓	✓	✓	✓	-
PADLOCK LOCK	✓	✓	✓	✓	✓	✓	✓	-	
+	TYPES OF LOCKS	AVAILABLE TYPES OF LOCKS: PAGE 16							
	ADDITIONAL OPTIONS	AVAILABLE ADDITIONAL OPTIONS: PAGE 10							
	COLOR OPTIONS	AVAILABLE COLOR OPTIONS: PAGE 20							

Four-level lockers

Doors available in:

METAL MFC HPL



STANDARD VERSION

DIMENSIONS	PRODUCT CODE	VD-15314-00	VD-15414-00	VD-15324-00	VD-15424-00	VD-15334-00	VD-15434-00	VD-15344-00	-
	HEIGHT	1500	1500	1500	1500	1500	1500	1500	-
	PRODUCT CODE	VD-18314-00	VD-18414-00	VD-18324-00	VD-18424-00	VD-18334-00	VD-18434-00	VD-18344-00	-
	HEIGHT	1800	1800	1800	1800	1800	1800	1800	-
	OVERALL WIDTH	300	400	600	800	900	1200	1200	-
	COLUMN WIDTH	1X300	1X400	2X300	2X400	3X300	3X400	4X300	-
DEPTH	490	490	490	490	490	490	490	-	
EQUIPMENT	LEGS HEIGHT 30	✓	✓	✓	✓	✓	✓	✓	-
	SHELF	-	-	-	-	-	-	-	-
	BAR WITH HOOKS	-	-	-	-	-	-	-	-
	CLOTHING HOOK	-	-	-	-	-	-	-	-
	KEY LOCK	✓	✓	✓	✓	✓	✓	✓	-
	PADLOCK LOCK	✓	✓	✓	✓	✓	✓	✓	-

+ TYPES OF LOCKS AVAILABLE TYPES OF LOCKS: PAGE 16
 ADDITIONAL OPTIONS AVAILABLE ADDITIONAL OPTIONS: PAGE 10
 COLOR OPTIONS AVAILABLE COLOR OPTIONS: PAGE 20

Clothing lockers L

Doors available in:

METAL HPL

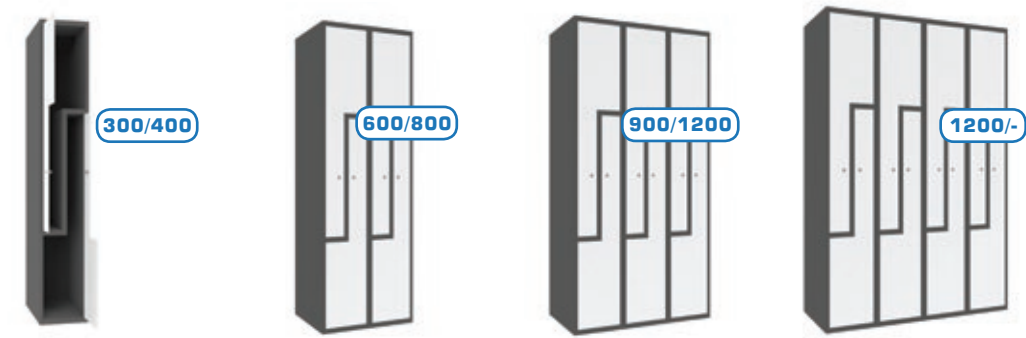

STANDARD VERSION

DIMENSIONS	PRODUCT CODE	VZ-15312-00	VZ-15412-00	VZ-15322-00	VZ-15422-00	VZ-15332-00	VZ-15432-00	VZ-15342-00	-
	HEIGHT	1500	1500	1500	1500	1500	1500	1500	-
	PRODUCT CODE	VZ-18312-00	VZ-18412-00	VZ-18322-00	VZ-18422-00	VZ-18332-00	VZ-18432-00	VZ-18342-00	-
	HEIGHT	1800	1800	1800	1800	1800	1800	1800	-
	OVERALL WIDTH	300	400	600	800	900	1200	1200	-
	COLUMN WIDTH	1X300	1X400	2X300	2X400	3X300	3X400	4X300	-
DEPTH	490	490	490	490	490	490	490	-	
EQUIPMENT	LEGS HEIGHT 30	✓	✓	✓	✓	✓	✓	✓	-
	SHELF	-	-	-	-	-	-	-	-
	BAR WITH HOOKS	✓	✓	✓	✓	✓	✓	✓	-
	CLOTHING HOOK	✓	✓	✓	✓	✓	✓	✓	-
	KEY LOCK	✓	✓	✓	✓	✓	✓	✓	-
	PADLOCK LOCK	✓	✓	✓	✓	✓	✓	✓	-

+ TYPES OF LOCKS AVAILABLE TYPES OF LOCKS: PAGE 16
 ADDITIONAL OPTIONS AVAILABLE ADDITIONAL OPTIONS: PAGE 10
 COLOR OPTIONS AVAILABLE COLOR OPTIONS: PAGE 20

VELA C lockers with central access

Lockers with central access

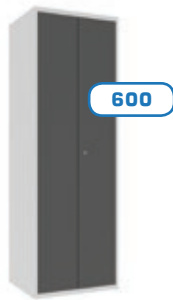

600

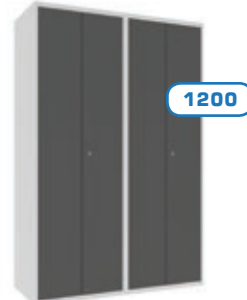

1200

WERSJA STANDARD

DIMENSIONS	PRODUCT CODE	VDC-15321-11	VDC-15341-11
	HEIGHT	1510	1510
	PRODUCT CODE	VDC-18321-11	VDC-18341-11
	HEIGHT	1810	1810
	OVERALL WIDTH	600	1200
	COLUMN WIDTH	300	300
	DEPTH	490	490
EQUIPMENT	LEGS HEIGHT 100	✓	✓
	SHELF	✓	✓
	BAR WITH HOOKS	✓	✓
	CLOTHING HOOK	✓	✓
	KEY LOCK	✓	✓
	PADLOCK LOCK	✓	✓
+	TYPES OF LOCKS	AVAILABLE TYPES OF LOCKS: PAGE 16	
	ADDITIONAL OPTIONS	AVAILABLE ADDITIONAL OPTIONS: PAGE 10	
	COLOR OPTIONS	AVAILABLE COLOR OPTIONS: PAGE 20	



hinge manufactured by ALSANIT

stable, aluminum rod and durable hooks manufactured by ALSANIT

as a standard - key lock or a padlock

doors available in: METAL 0,7 mm, HPL 10 mm, MFC 18 mm

body and back made of galvanized steel: 0.7 mm powder-coated

adjustable leg

available additional options

page 10 →

available lock options

page 10 →

available colors

page 20 →



Smooth doors

Standard execution.



Ideal for employee lockers.
Additional partition as standard.

At no extra charge, we install the partition separating the area for clean clothes and dirty clothes. A must-have in employee lockers.



Metal doors with perforation

Possible to be done at no extra charge.



Excellent for schools.
Doors reinforced with OMEGA profile.

The additional reinforcement of metal doors ensures that even budget lockers are durable and resilient at schools.



Doors with a plexiglass window

Available for a surcharge.



Why choose VELA lockers?

Vela offers a wide range of configuration options at an affordable price.

It is a system that utilizes metal bodies optimally tailored to the needs of users in places such as schools, workplaces, and offices. There is the possibility of using various door options - from choosing the material, METAL, HPL, or MFC, to their function, and matching the color.

Additional options



AVAILABLE FOR LOCKERS MADE OF:

	HPL	METAL	MFC
PLATE 30X30	✓	✓	✓
PLATE 35X60	✓	✓	✓
PLATE 45X120	✓	✓	✓
ENGRAVING	✓	-	-
BAR WITH HOOKS	✓	✓	✓
ANTI-BURGLARY SYSTEM	✓	-	✓

POSSIBILITY OF MAKING FROM:

	HPL	METAL	MFC
CUSTOM DIVISION	✓	✓	✓
SLANTED ROOF	✓	✓	-
PLINTH	✓	✓	✓
LEG COVERS	✓	-	✓



Connecting lockers into wardrobes

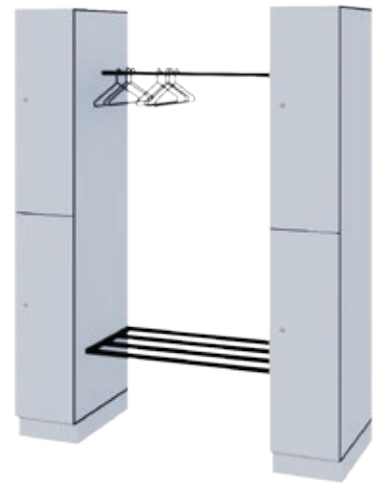
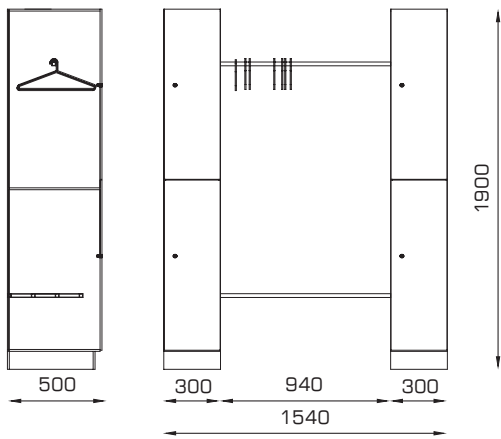

Side and corner covers

HPL / MFC / METAL



MIRROR

HPL / MFC / METAL

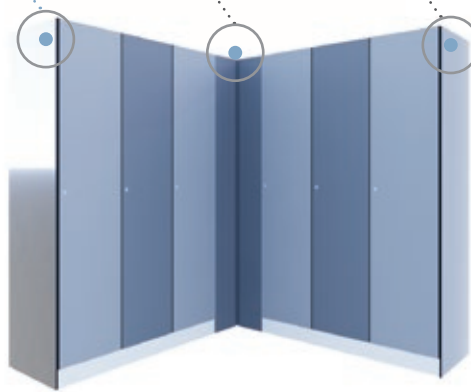

VANITY - functional and compact





BENCHES

Benches are the perfect add on to any locker room.

Properly chosen, they can add character to the interior - make it more friendly and inviting.

available
colors

page 20 →



Benches PRO-FI

HPL

← back

10 mm

12 mm

Classic approach

Aluminum construction with seats made of HPL.
Standard ALSANIT benches.

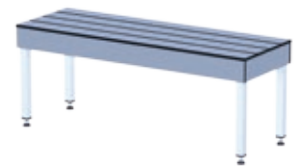
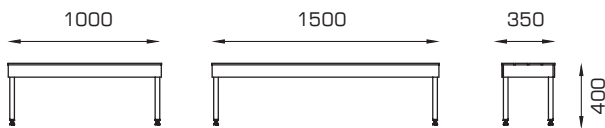
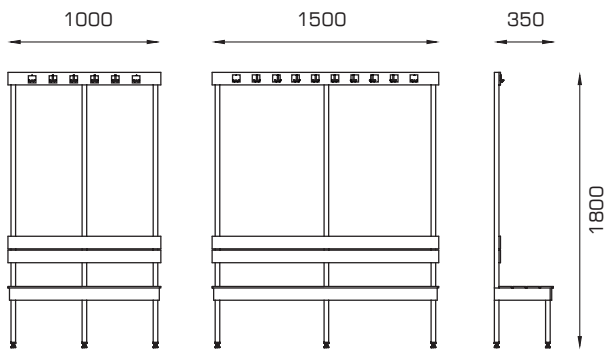

Benches LO-FI

HPL

10 mm

12 mm

Metal bench with an eye-catching seat

An elegant combination of steel and wood-like HPL panels.
Optionally include hooks.

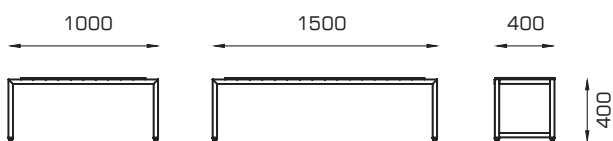
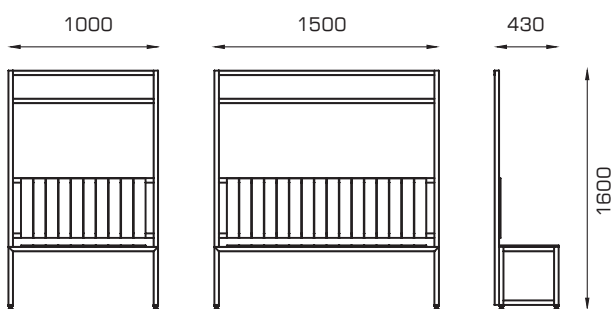

Benches HI-FI

HPL

10 mm

12 mm

Openwork backs

Steel frames with HPL seats.

Optionally include hooks.

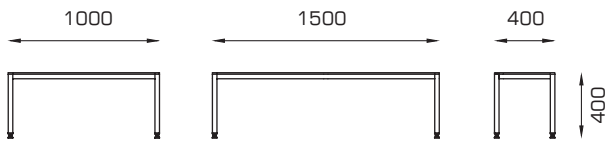
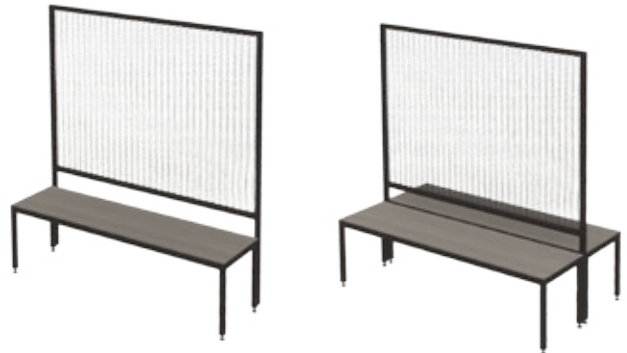
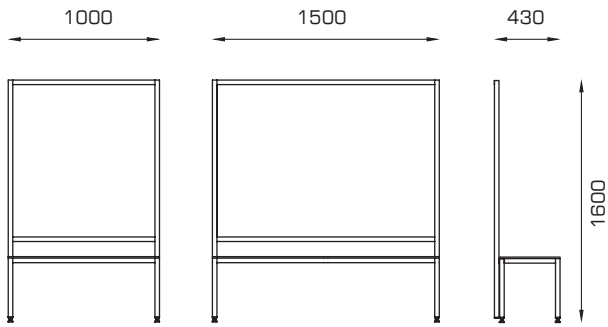

Options - available for any model

Option with low backrest

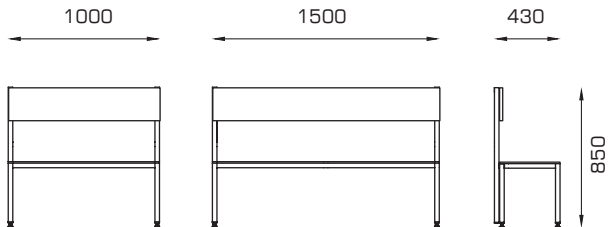

Optional slat direction for seats

Optional shoe shelf



Upholstered benches

← back

Elegance and comfort

The combination of a classic bench with elegant upholstery
- beauty and elegance encapsulated in a simple minimalist
form. Perfect for both modern and classical interiors.

IRIS

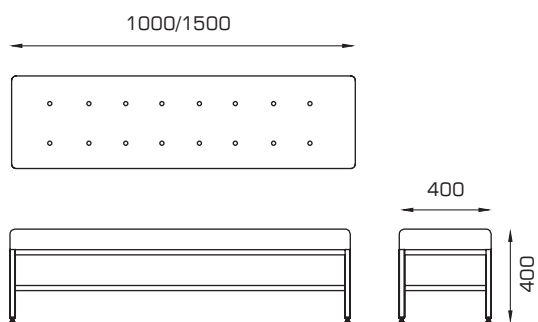

LANDO

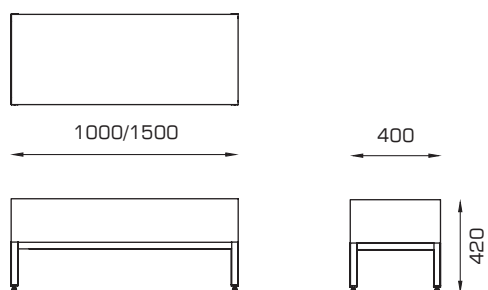

Locks for lockers

Security - a common value of the locks we offer, that is why we only provide those from reputable manufacturers. Below, we describe three additional features that guided us in selecting the locks for our products.

Waterproofnes - prepared to work in any conditions.

Prioritizing quality above all, we have decided that all locks offered by us are suitable for use in moist areas.

Interchangeability - lock models can be exchanged at any time, changing from a lower model to a higher one. This way, the locker room can be modernized without the need for costly door replacement. When changing locks to deposit or electronic locks, additional holes will have to be made in doors.

Availability - don't waste time waiting.

A strong aspect of our offer is the availability of locks on stock, significantly reducing the time needed to complete the order. For projects with slot or digital locks above 200 compartments, please contact us to confirm availability.

Cam locks, the locks we offer have a 1/1000 combination, meaning the chance of opening with your key any another locker is 0.1%.



Padlock locks, an alternative to key locks is padlocks. The recommended shackle diameter for padlocks is 5-7 mm.



The option to use any lock.

We are not limited to our own selection; we can integrate the locker with any lock specified by the client.

Code locks are maintenance-free solutions. All code locks offered by us have a master key opening option in case the code is forgotten.



Deposit locks, Coin-operated or token-operated locks are capable of accepting coins or tokens into a special container. Locks can operate on coins of 1/2 EUR. In case of key loss, locks can be opened using a master key.



Electronic lock that support the standard RFID are modern programmable locks operated by CARDS, WRISTBANDS, or other RFID TOKENS. Available in both OFFLINE versions powered by batteries and ONLINE versions powered externally.





SMART LOCKER transforms lockers into solutions

ALSANIT introduces innovative solutions in the field of lockers with smart locks, enabling electronic control over them.

Thanks to cooperation with the renowned brand SMART LOCKER, representing the most advanced intelligent locking system available on the market, we can confidently offer this solution to our customers.

SMART LOCKER stands out not only for its ease of use but also for its rich configuration options, ensuring easy management and convenient use.



The possibility of integration for any ALSANIT locker system



Full service including installation and training



The ability to integrate with the client's database



The ability to customize the software to individual needs

SMART LOCKER is an intelligent locker system that introduces a new era of facility management.

Examples of applications by industry

INDUSTRIES

	OFFICES	SCHOOLS	STORES	PHARMACY	FACTORIES	SPORTS FACILITIES	LOGISTICS SHIPMENTS	HEALTHCARE	PUBLIC AREAS	GASTRONOMY
FUNCTIONS										
STORAGE	✓	✓				✓		✓	✓	✓
DISPENSE	✓	✓	✓	✓	✓	✓	✓	✓		
DROP OFF / PICK UP	✓	✓	✓		✓		✓		✓	
CLOAKROOM	✓	✓	✓		✓	✓	✓	✓	✓	✓

- Receive all your parcels from any carrier in one place.
- Effortlessly dispense workwear or distribute mail.
- Exchange documents or keys using easily managed lockers.
- Reduce costs by flexibly assigning users to lockers in the changing room.
- Control the circulation of tools or electronic equipment.
- Earn money by selling oversized items in hospitals, sports facilities, etc.

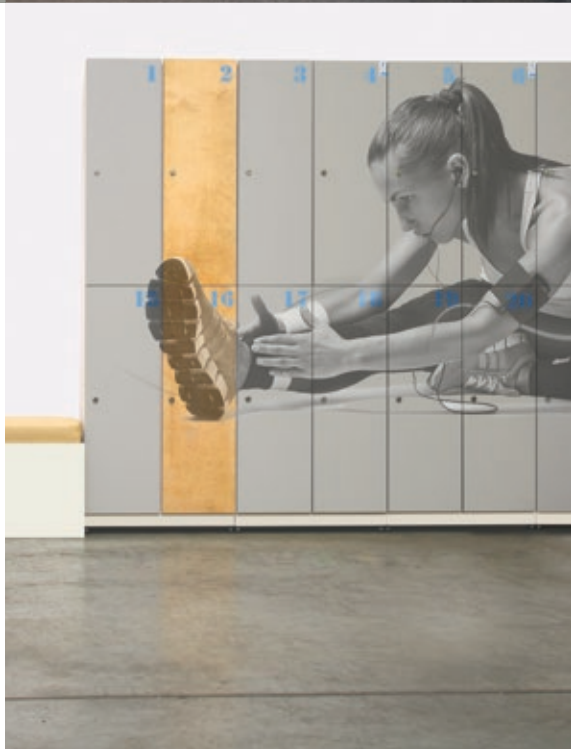



The **STOCK** version - at no extra cost

Take advantage of our extensive stock collection of available HPL, MFC, and GLASS, as well as metal paint, and configure furniture at no extra cost. There are countless configuration possibilities.

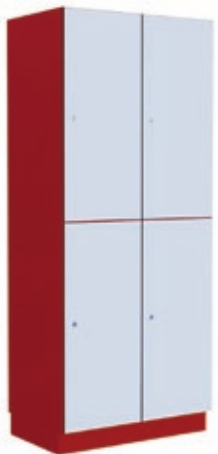

The **EXTENDED** Version - extra charge

If you would like to have the furniture bodies made in colors other than those originally designated for bodies, there is an additional surcharge of +15%.



BESPOKE Version - custom color scheme upon individual request

In addition to non-standard board colors, we can also enrich the project with graphics or decals. If you wish for colors not available in our warehouse collection, you can choose any board color, paint, or decor from the available palette, and we will order it for you.

HPL + MFC - available from the ALSANIT board suppliers' collections
PAINT FOR METAL + GLASS - available from the RAL color collection

COLORS stock collection

HPL

LOCKERS

HPL BUILT-INS

CUBICLES

CONTRACT FURNITURE

standard colors of locker bodies
standard colors of Sandwich Panels

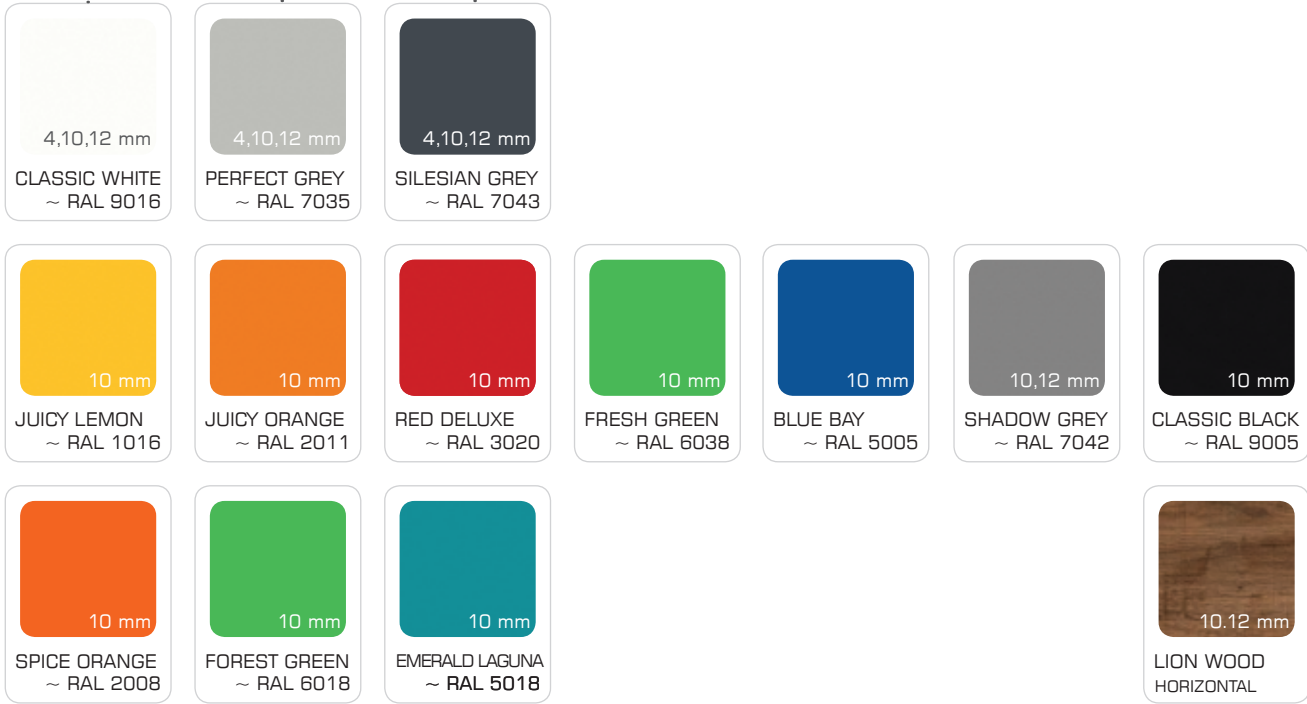

colors available only for lockers and furniture

METAL

LOCKERS

standard colors of locker bodies

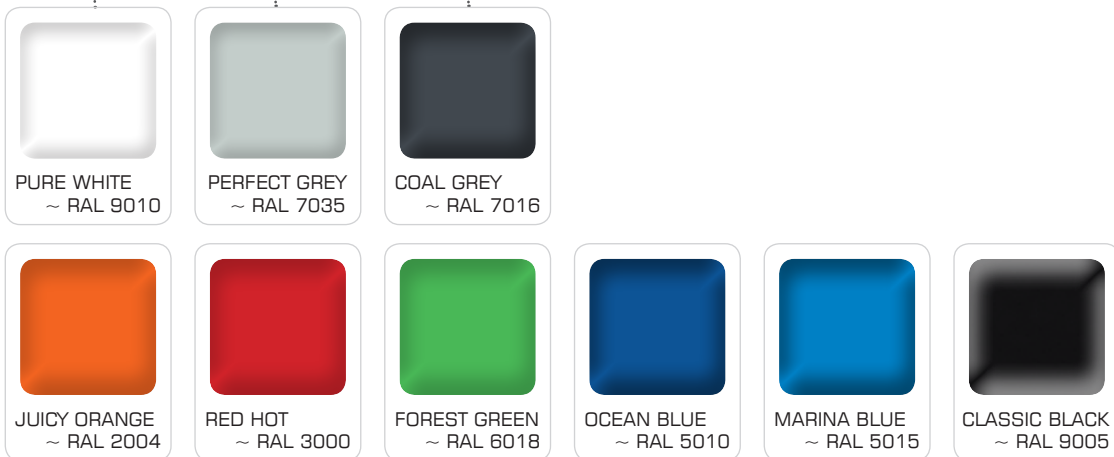

* sample colors

MFC

LOCKERS

CUBICLES

CONTRACT FURNITURE



the color range is also available in the **HIGH GLOSS** version

GLASS

LOCKERS

CUBICLES



* sample colors



20+

20 years of experience

25+

sales to over 25 countries

2600+

2600 projects annually

8000+

sqm of ALSANIT's hall space

40000+

doors produced annually

Metal furniture is one of our specialties - we design and manufacture it ourselves.

We pay attention to every detail to meet the users' requirements and provide the best solution for a budget-friendly metal locker.



ALSANIT®

Alsanit Sp. z o.o.
ul. Wieleńska 2, 64-980 Trzcianka, POLSKA

+48 67 253 23 60
export@alsanit.eu
www.alsanit.eu